

The Tropical Atmosphere: Hurricane Incubator



Images from journals published by the American Meteorological Society are copyright © AMS and used with permission.

A One-Dimensional Description of the Tropical Atmosphere

Elements of Thermal Balance: Solar Radiation

- Luminosity: $3.9 \times 10^{26} \text{ J s}^{-1} = 6.4 \times 10^7 \text{ Wm}^{-2}$
at top of photosphere
- Mean distance from earth: $1.5 \times 10^{11} \text{ m}$
- Flux density at mean radius of earth

$$S_0 \equiv \frac{L_0}{4\pi d^2} = 1370 \text{ Wm}^{-2}$$

Stefan-Boltzmann Equation: $F = \sigma T^4$

$$\sigma = 5.67 \times 10^{-8} \text{ Wm}^{-2} \text{ K}^{-4}$$

Sun: $\sigma T^4 = 6.4 \times 10^7 \text{ Wm}^{-2}$

$\rightarrow T \approx 6,000 \text{ K}$

Disposition of Solar Radiation:

$$\text{Total absorbed solar radiation} = S_0 \left(1 - a_p\right) \pi r_p^2$$

$a_p \equiv$ planetary albedo ($\approx 30\%$)

$$\text{Total surface area} = 4\pi r_p^2$$

$$\text{Absorption per unit area} = \frac{S_0}{4} \left(1 - a_p\right)$$

Absorption by clouds, atmosphere, and surface

Terrestrial Radiation:

Effective emission temperature:

$$\sigma T_e^4 \equiv \frac{S_0}{4} (1 - a_p)$$

Earth: $T_e = 255K = -18^\circ C$

Observed average surface temperature = $288K = 15^\circ C$

Highly Reduced Model

- Transparent to solar radiation
- Opaque to infrared radiation
- Blackbody emission from surface and each layer

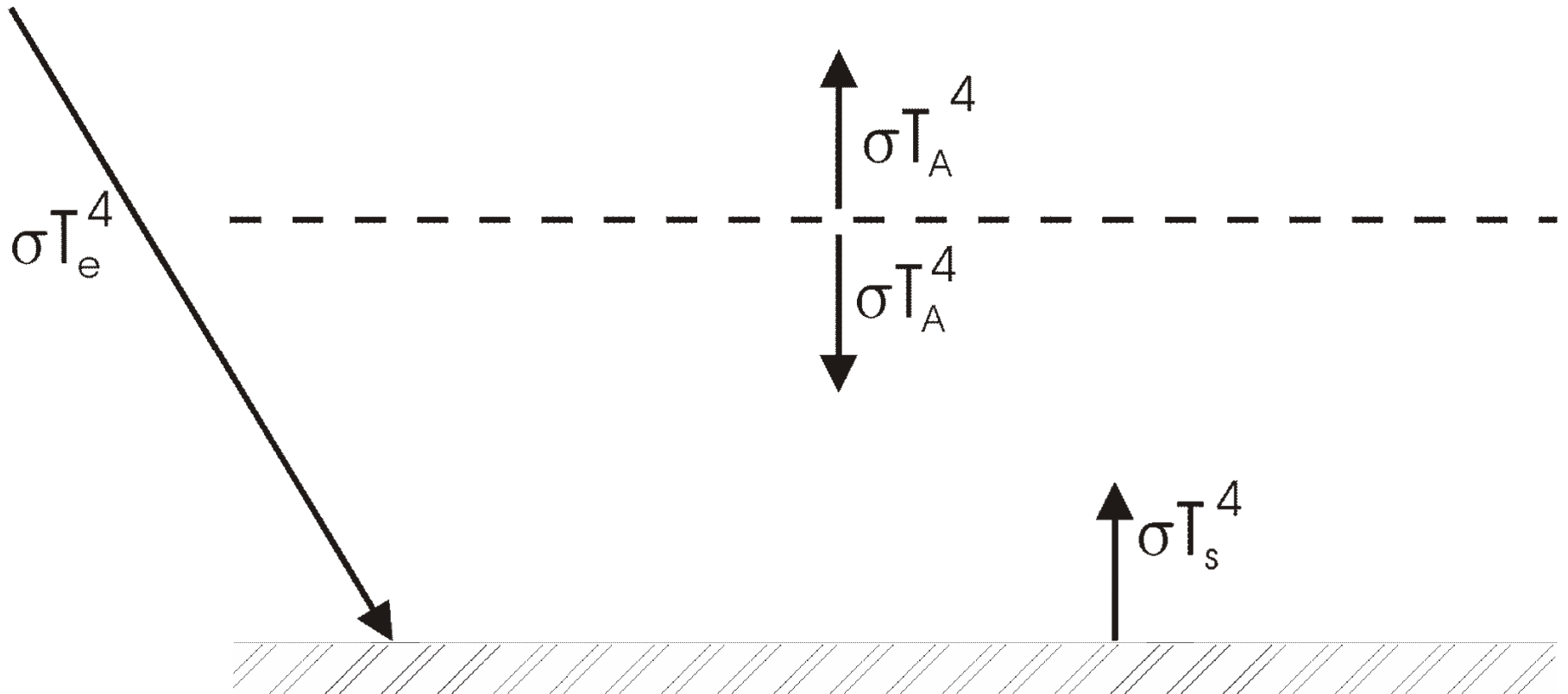

Radiative Equilibrium:

Top of Atmosphere:

$$\sigma T_A^4 = \frac{S_0}{4} (1 - a_p) = \sigma T_e^4$$

$$\rightarrow \boxed{T_A = T_e}$$

Surface:

$$\sigma T_s^4 = \sigma T_A^4 + \frac{S_0}{4} (1 - a_p) = 2\sigma T_e^4$$

$$\rightarrow \boxed{T_s = 2^{1/4} T_e} = 303 \text{ K}$$

Surface temperature too large because:

- Real atmosphere is not opaque
- Heat transported by convection as well as by radiation

Extended Layer Models

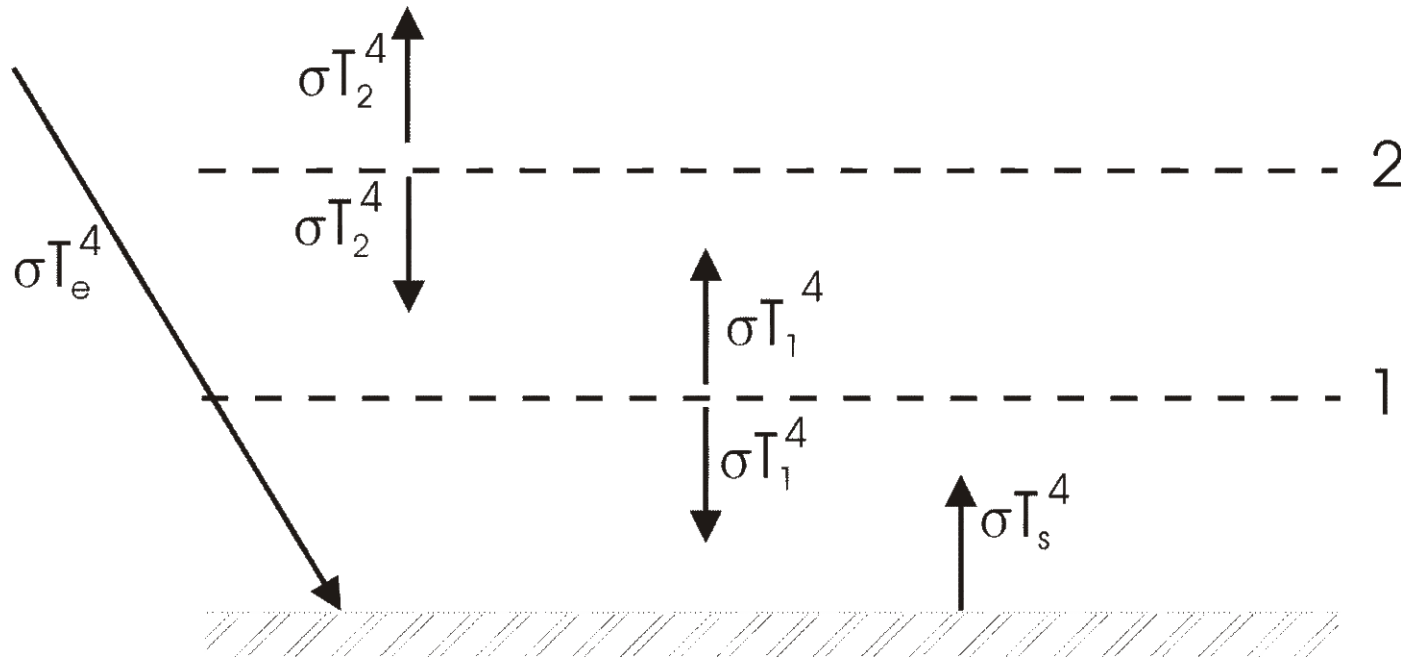

$$TOA: \quad \sigma T_2^4 = \sigma T_e^4 \rightarrow T_2 = T_e$$

$$Middle\ Layer: \quad 2\sigma T_1^4 = \sigma T_2^4 + \sigma T_s^4 = \sigma T_e^4 + \sigma T_s^4$$

$$Surface: \quad \sigma T_s^4 = \sigma T_e^4 + \sigma T_1^4$$

$$\rightarrow T_s = 3^{1/4} T_e \quad T_1 = 2^{1/4} T_e$$

Effects of emissivity < 1

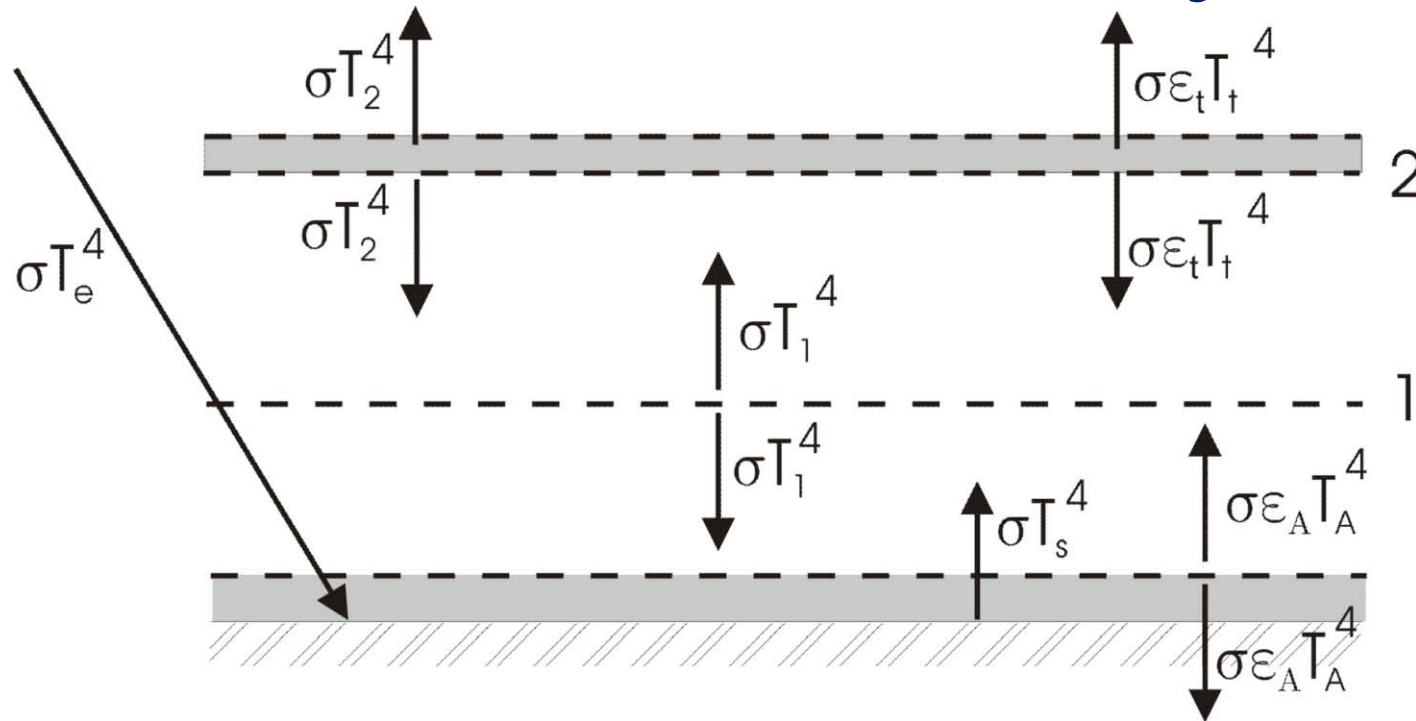

$$\text{Surface: } 2\epsilon_A \sigma T_A^4 = \epsilon_A \sigma T_1^4 + \epsilon_A \sigma T_s^4$$

$$\rightarrow T_A = \left(\frac{5}{2}\right)^{1/4} T_e \approx 321K < T_s$$

$$\text{Stratosphere: } 2\epsilon_t \sigma T_t^4 = \epsilon_A \sigma T_2^4$$

$$\rightarrow T_t = \left(\frac{1}{2}\right)^{1/4} T_e \approx 214K < T_e$$

Full calculation of radiative equilibrium:

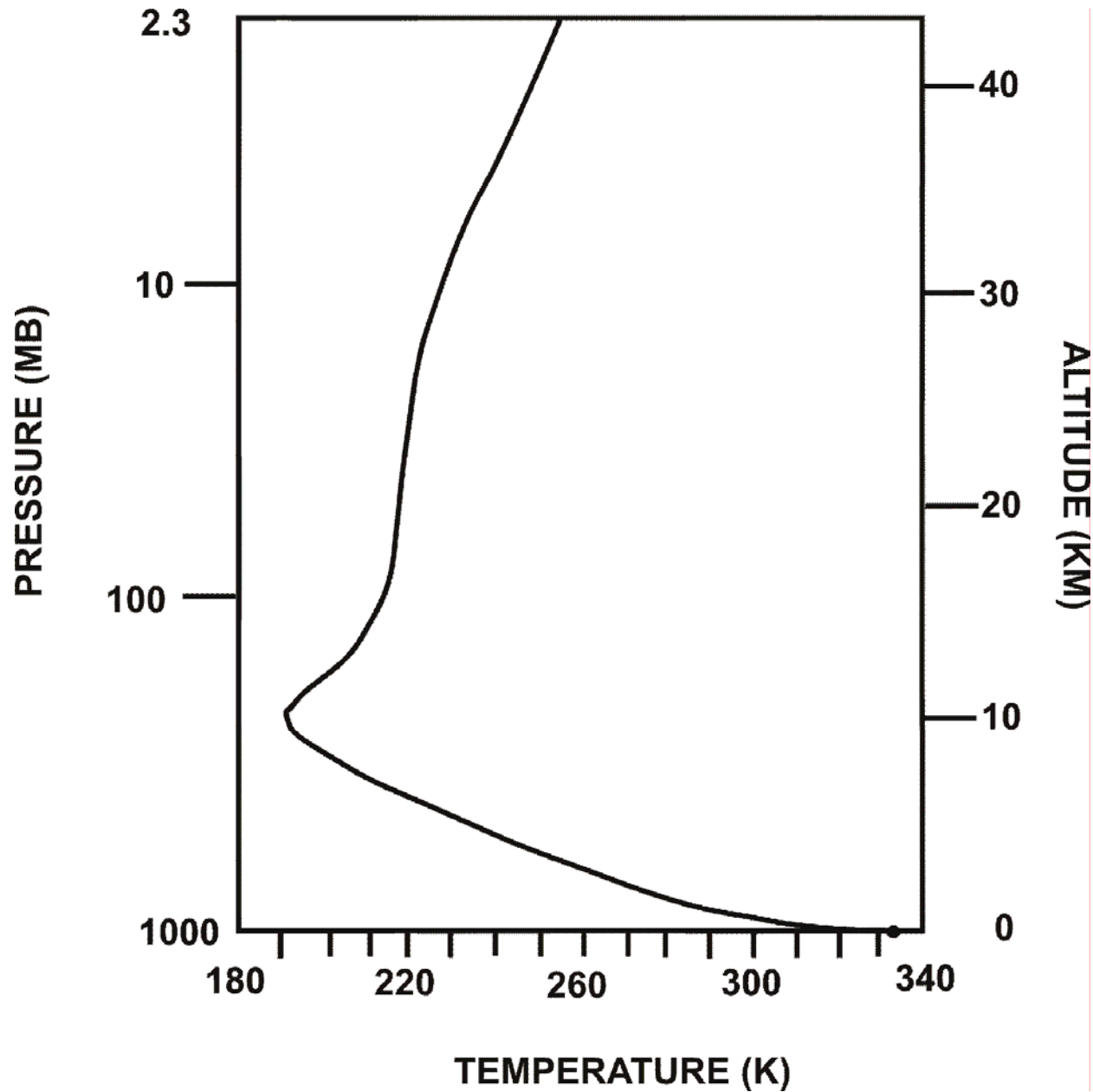

Problems with radiative equilibrium solution:

- Too hot at and near surface
- Too cold at a near tropopause
- Lapse rate of temperature too large in the troposphere
- (But stratosphere temperature close to observed)

Missing ingredient: Convection

- As important as radiation in transporting enthalpy in the vertical
- Also controls distribution of water vapor and clouds, the two most important constituents in radiative transfer

When is a fluid unstable to convection?

- Pressure and hydrostatic equilibrium
- Buoyancy
- Stability

Hydrostatic equilibrium:

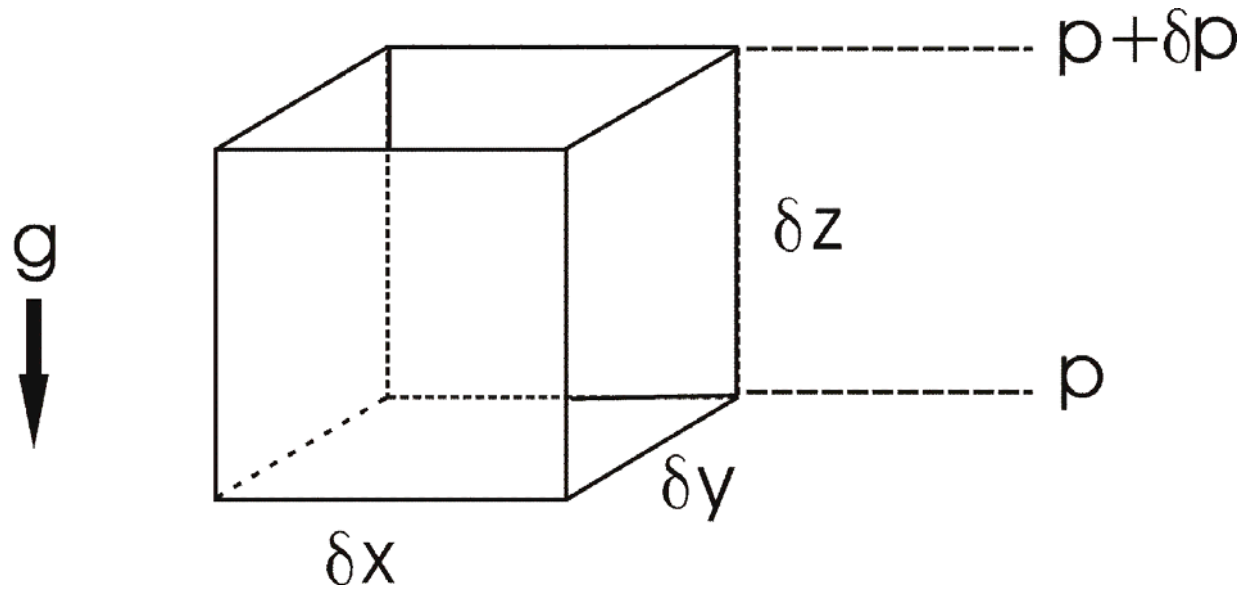

$$\text{Weight: } -g\rho\delta x\delta y\delta z$$

$$\text{Pressure: } p\delta x\delta y - (p + \delta p)\delta x\delta y$$

$$F = MA: \quad \rho\delta x\delta y\delta z \frac{dw}{dt} = -g\rho\delta x\delta y\delta z - \delta p\delta x\delta y$$

$$\frac{dw}{dt} = -g - \alpha \frac{\partial p}{\partial z}, \quad \alpha = \frac{1}{\rho} = \text{specific volume}$$

Pressure distribution in atmosphere at rest:

Ideal gas : $\alpha = \frac{RT}{p}$, $R \equiv \frac{R^*}{\bar{m}}$

Hydrostatic : $\frac{1}{p} \frac{\partial p}{\partial z} = \frac{\partial \ln(p)}{\partial z} = -\frac{g}{RT}$

Isothermal case : $p = p_0 e^{-z/H}$, $H \equiv \frac{RT}{g} = \text{"scale height"}$

Earth: $H \sim 8 \text{ Km}$

Buoyancy:

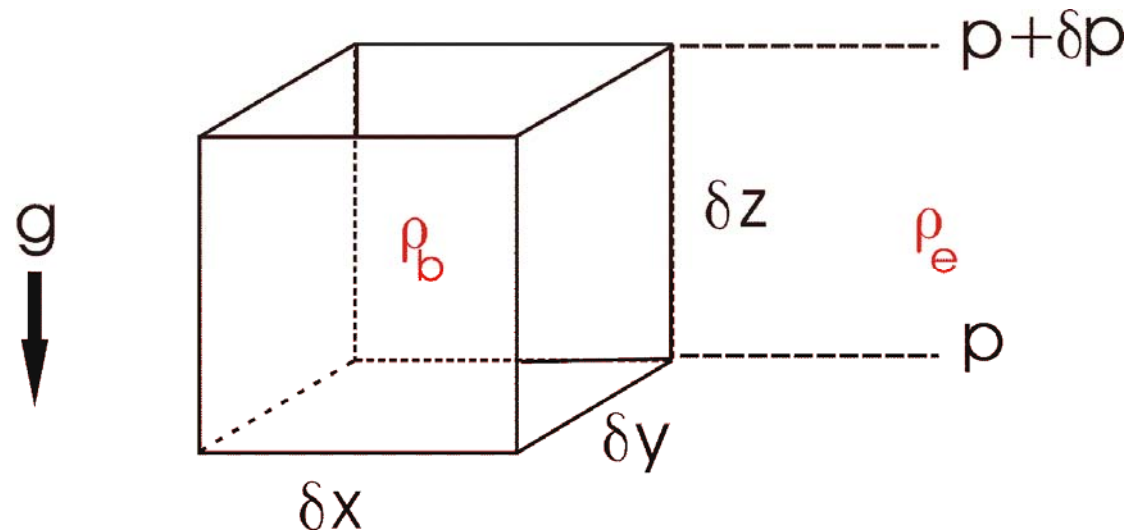

$$\text{Weight: } -g \rho_b \delta x \delta y \delta z$$

$$\text{Pressure: } p \delta x \delta y - (p + \delta p) \delta x \delta y$$

$$F = MA: \quad \rho_b \delta x \delta y \delta z \frac{dw}{dt} = -g \rho_b \delta x \delta y \delta z - \delta p \delta x \delta y$$

$$\frac{dw}{dt} = -g - \alpha_b \frac{\partial p}{\partial z} \quad \text{but} \quad \frac{\partial p}{\partial z} = - \frac{g}{\alpha_e}$$

$$\rightarrow \frac{dw}{dt} = g \frac{\alpha_b - \alpha_e}{\alpha_e} \equiv B$$

Buoyancy and Entropy

Specific Volume: $\alpha = 1/\rho$

Specific Entropy: s

$\alpha = \alpha(p, s)$

Maxwell: $\left(\frac{\partial \alpha}{\partial s}\right)_p = \left(\frac{\partial T}{\partial p}\right)_s$

$$(\delta \alpha)_p = \left(\frac{\partial \alpha}{\partial s}\right)_p \delta s = \left(\frac{\partial T}{\partial p}\right)_s \delta s$$

$$B = g \frac{(\delta \alpha)_p}{\alpha} = \frac{g}{\alpha} \left(\frac{\partial T}{\partial p}\right)_s \delta s = - \left(\frac{\partial T}{\partial z}\right)_s \delta s \equiv \Gamma \delta s$$

The adiabatic lapse rate:

First Law of Thermodynamics :

$$\begin{aligned}\dot{Q} &= T \frac{ds_{rev}}{dt} = c_v \frac{dT}{dt} + p \frac{d\alpha}{dt} \\ &= c_v \frac{dT}{dt} + \frac{d(\alpha p)}{dt} - \alpha \frac{dp}{dt} \\ &= (c_v + R) \frac{dT}{dt} - \alpha \frac{dp}{dt} \\ &= c_p \frac{dT}{dt} - \alpha \frac{dp}{dt}\end{aligned}$$

Adiabatic : $c_p dT - \alpha dp = 0$

Hydrostatic : $c_p dT + g dz = 0$

$$\rightarrow \left(\frac{dT}{dz} \right)_s = - \frac{g}{c_p} \equiv -\Gamma_d$$

$$\Gamma = g / c_p$$

Earth's atmosphere:

$$\Gamma = 1 K / 100 m$$

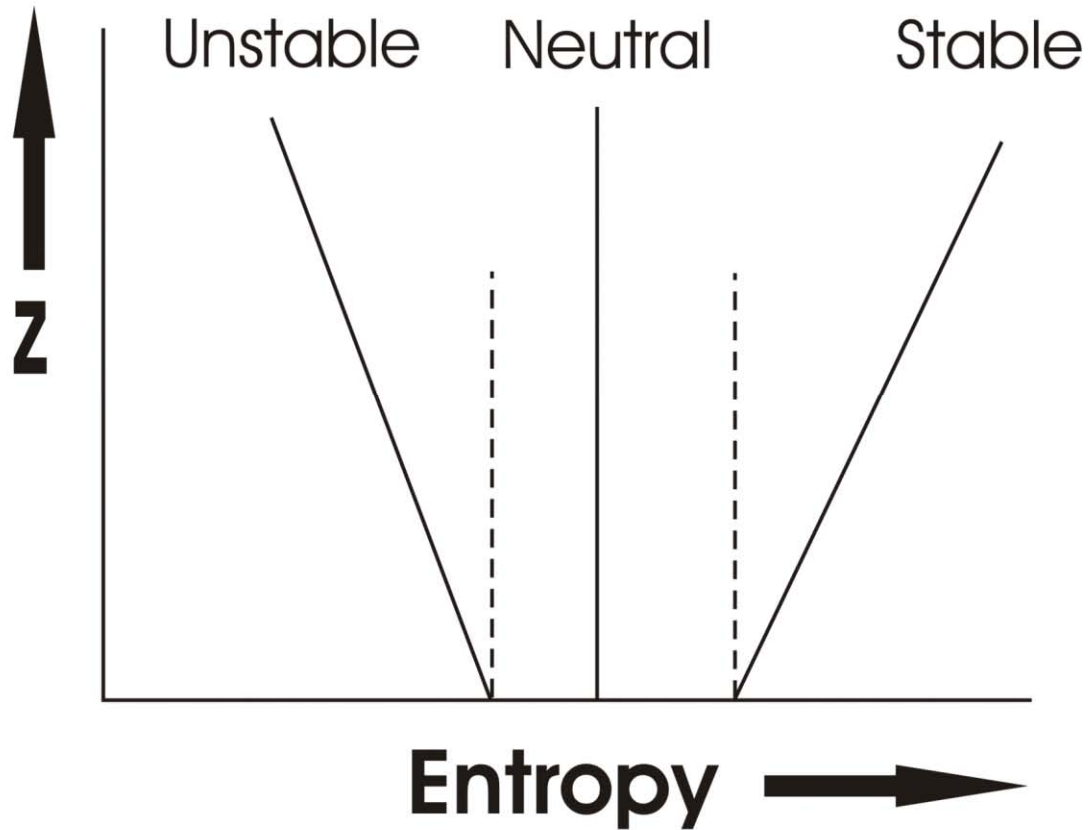

Model Aircraft Measurements (Renno and Williams, 1995)

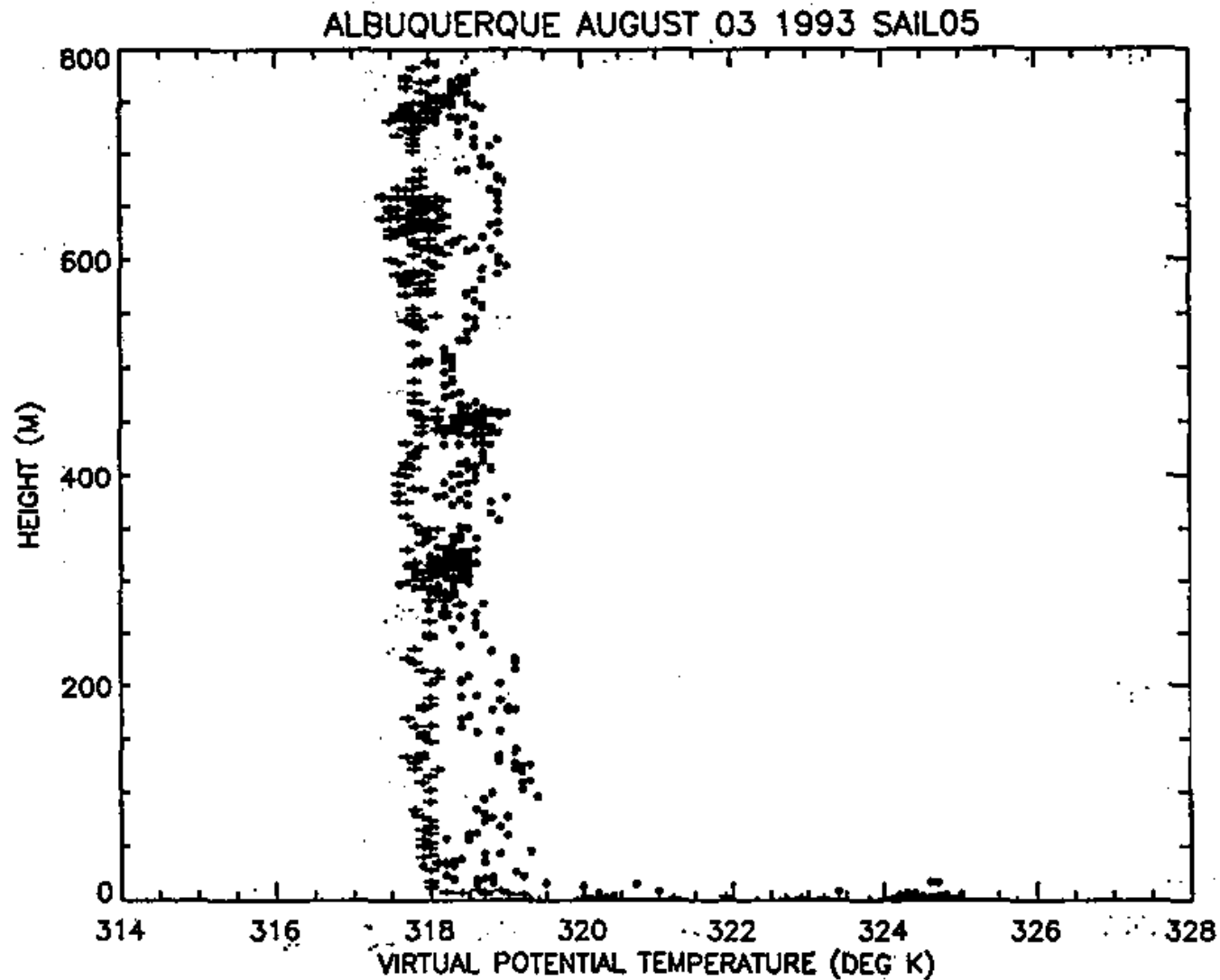

Radiative equilibrium is unstable in the
troposphere

Re-calculate equilibrium assuming that
tropospheric stability is rendered neutral by
convection:

Radiative-Convective Equilibrium

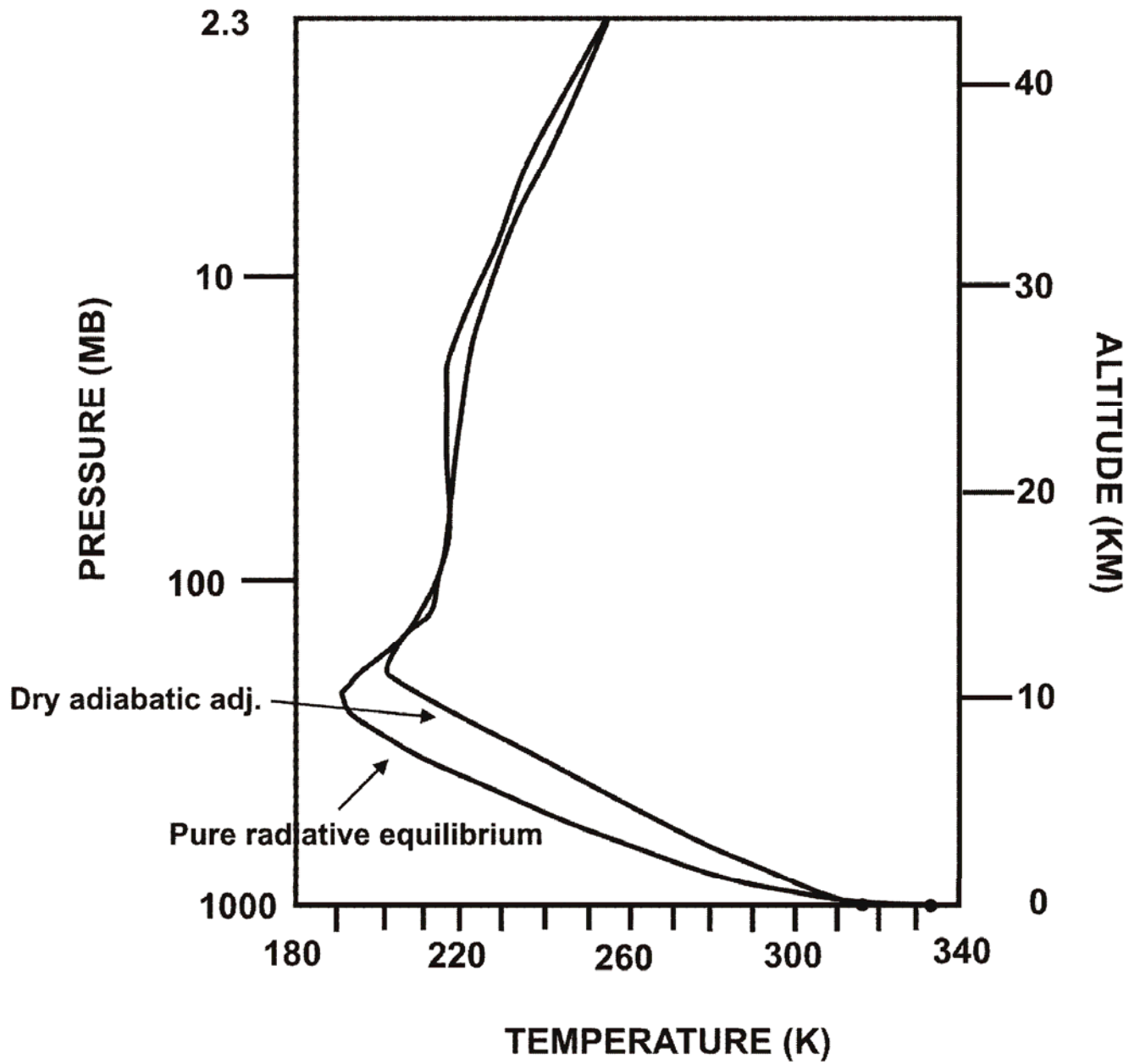

Better, but still too hot at surface, too cold at tropopause

Above a thin boundary layer, most atmospheric convection involved phase change of water:

Moist Convection



Moist Convection

- Significant heating owing to phase changes of water
- Redistribution of water vapor – most important greenhouse gas
- Significant contributor to stratiform cloudiness – albedo and longwave trapping

Stability Assessment using Tephigrams:

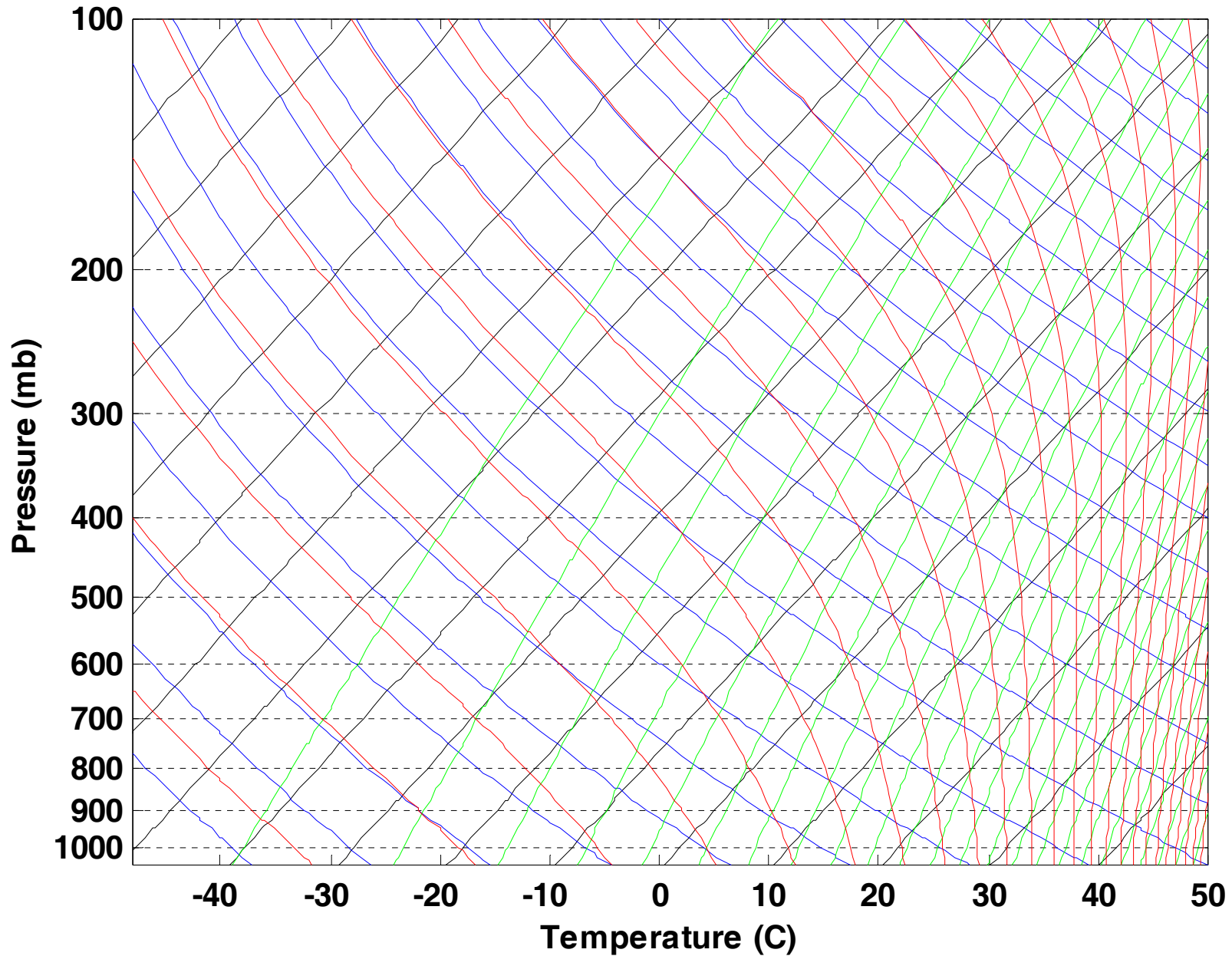

Stability Assessment using Tephigrams:

Convective Available Potential Energy
(CAPE):

$$\begin{aligned} CAPE_i &\equiv \int_{p_n}^{p_i} (\alpha_p - \alpha_e) dp \\ &= \int_p^{p_i} R_d (T_{\rho_p} - T_{\rho_e}) d \ln(p) \end{aligned}$$

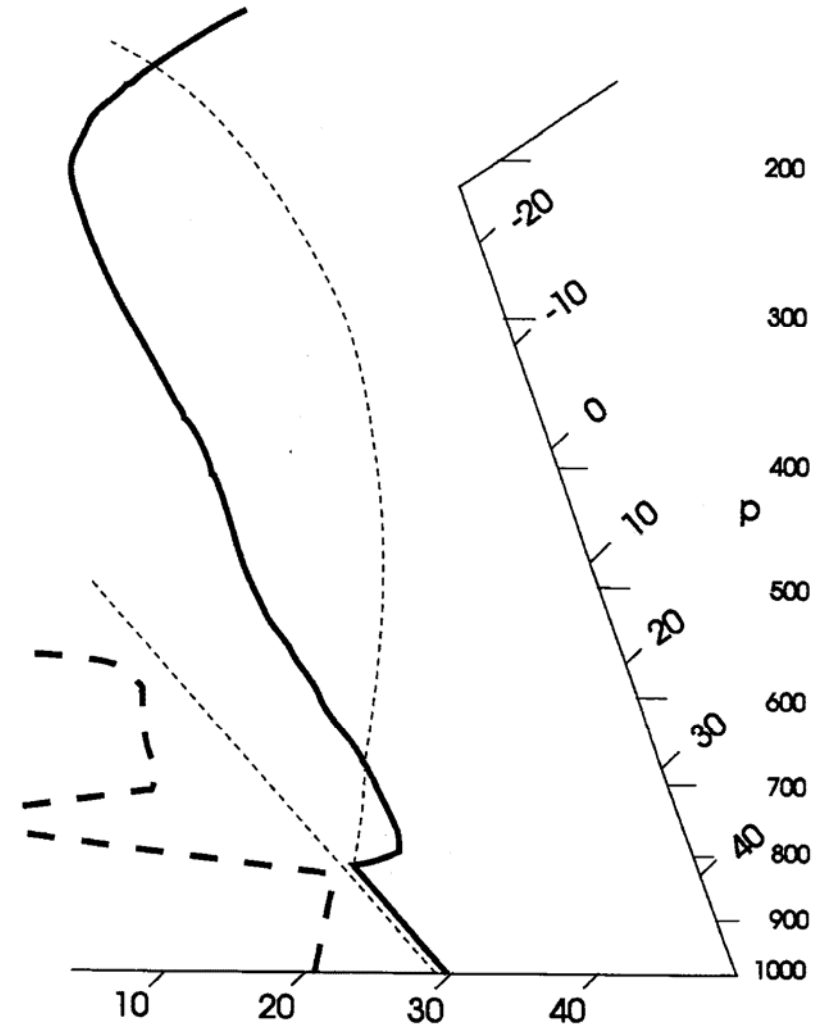

Tropical Soundings: Virtually no CAPE

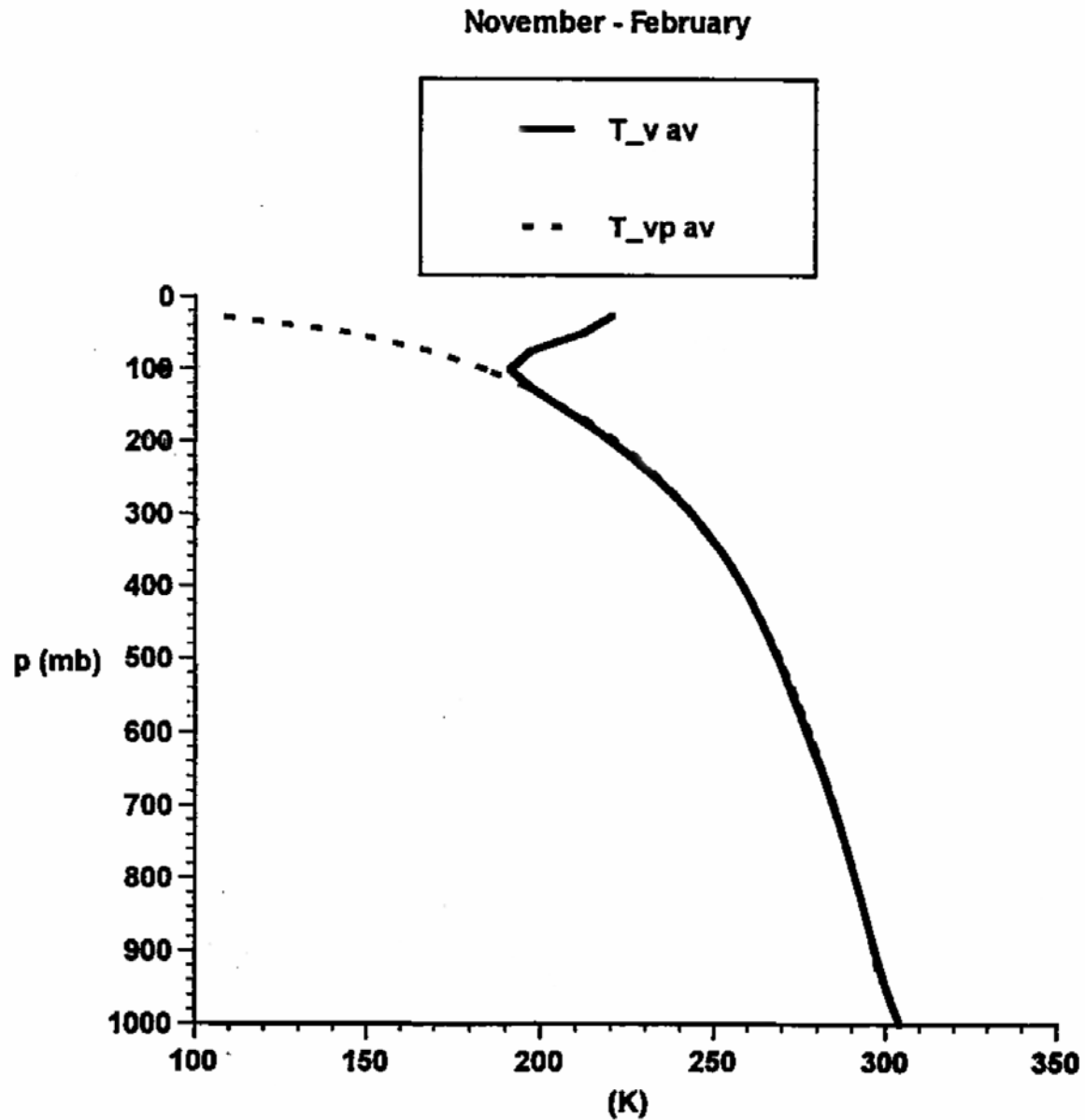

Annual Mean Kapingamoronga

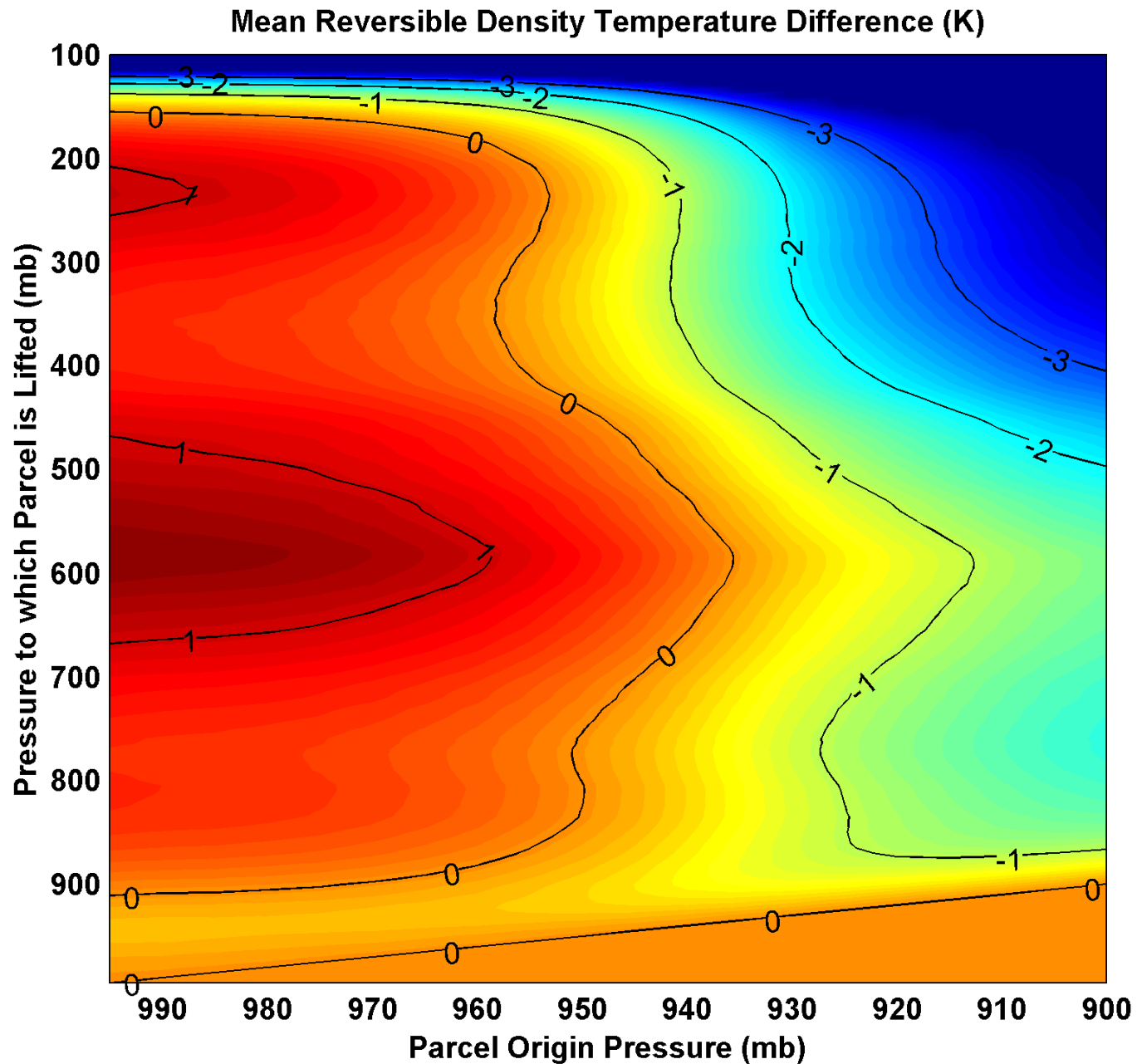

A satellite image of a tropical cyclone, showing a distinct eye and spiral cloud bands over a dark ocean. The text is overlaid on the image.

**Tropical Cyclones: Steady State
Physics. Where does the Energy
Come From?**

HURRICANE INEZ

SEPTEMBER 28, 1966

EQUIVALENT POTENTIAL TEMPERATURE (K)

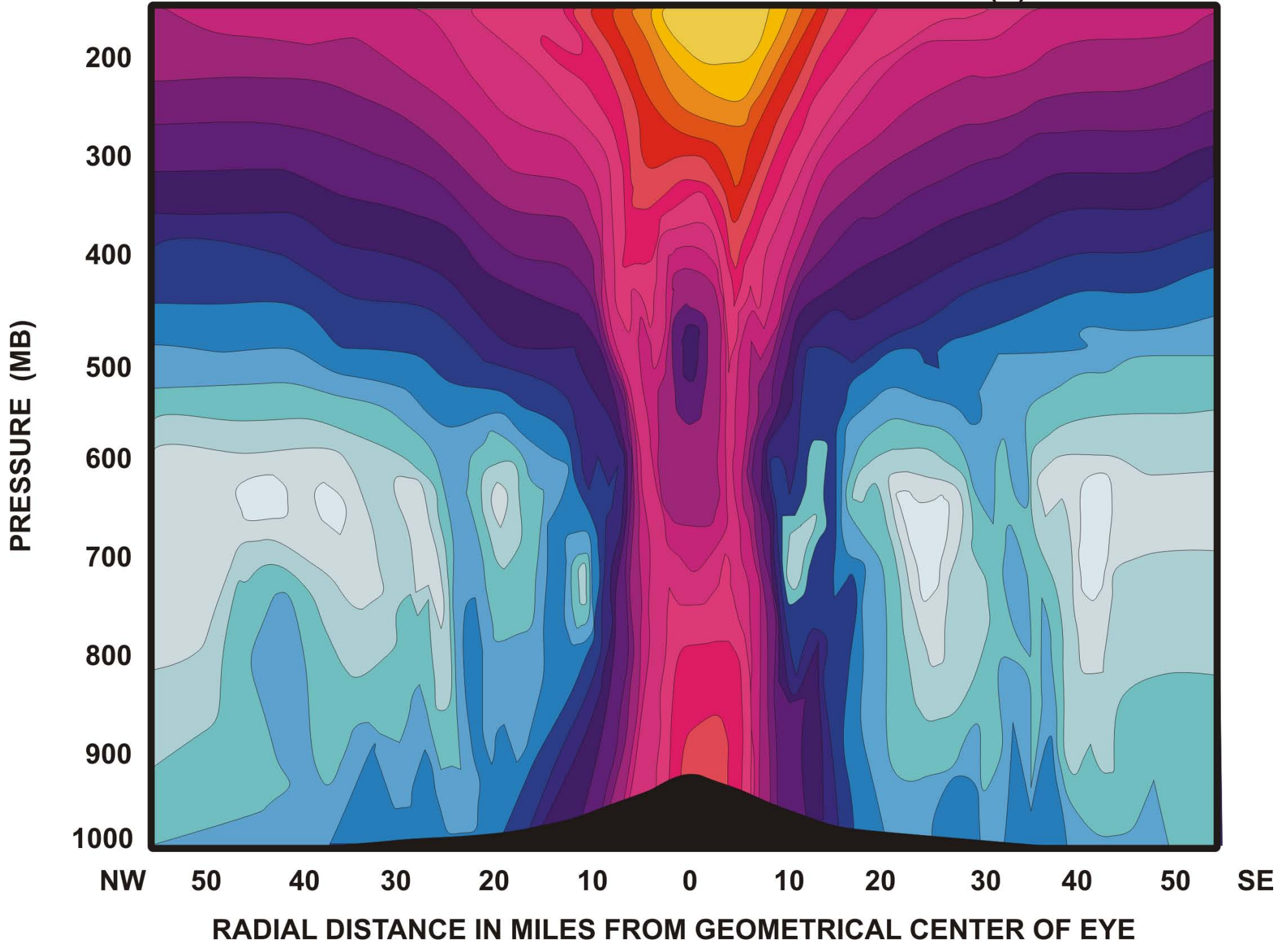

HURRICANE "HILDA" OCTOBER 1, 1964
 VERTICAL CROSS-SECTION OF ABSOLUTE ANGULAR
 MOMENTUM $\bar{V}_\theta r + fr^2/2$ UNITS (100 N.Mi.²/hr.)

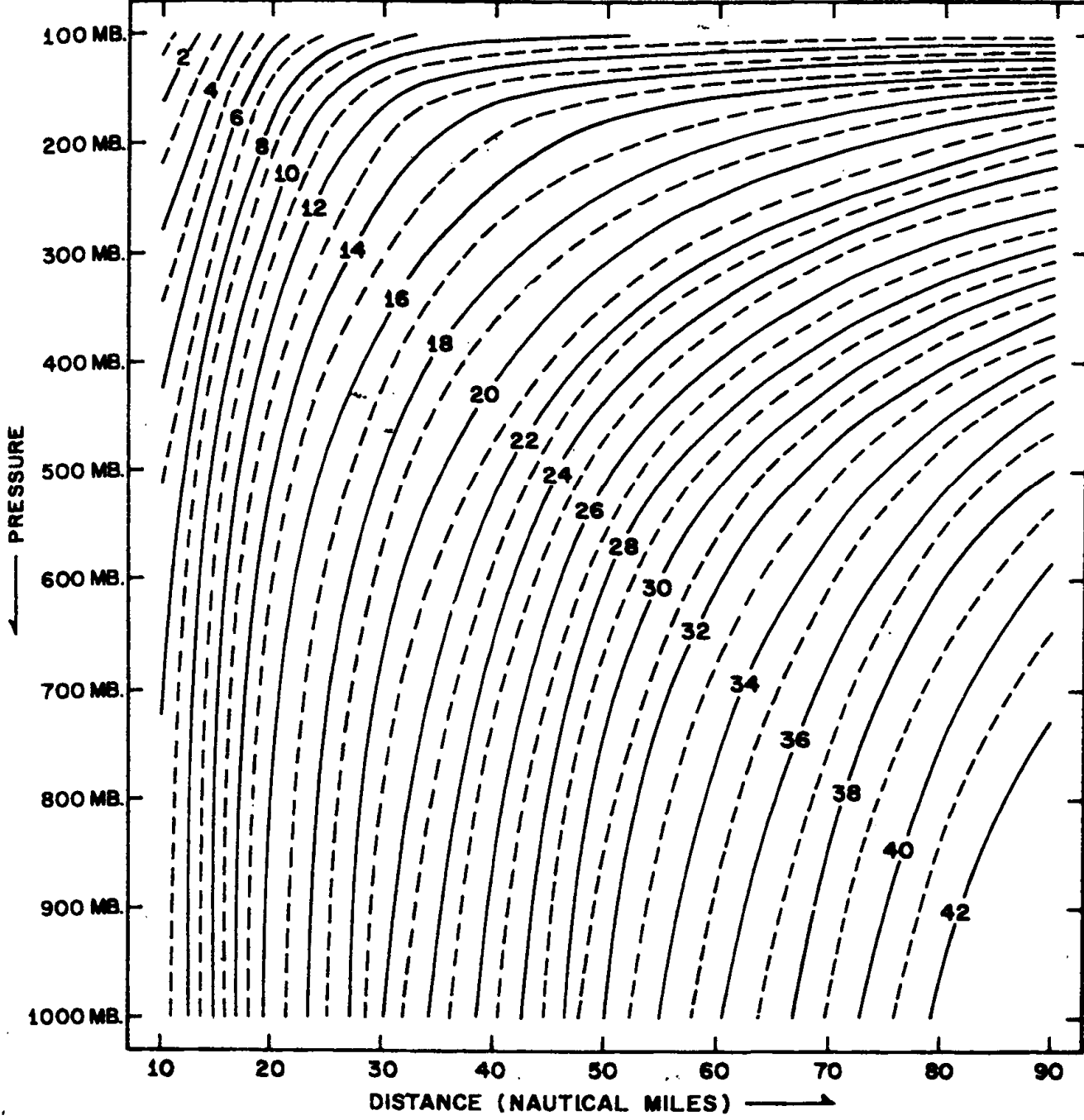

Angular
 momentum
 per unit mass

$$M = rV + \Omega \sin(\theta) r^2$$

Energy Production

Equivalent potential temperature (K), from 334.4955 to 373.3983

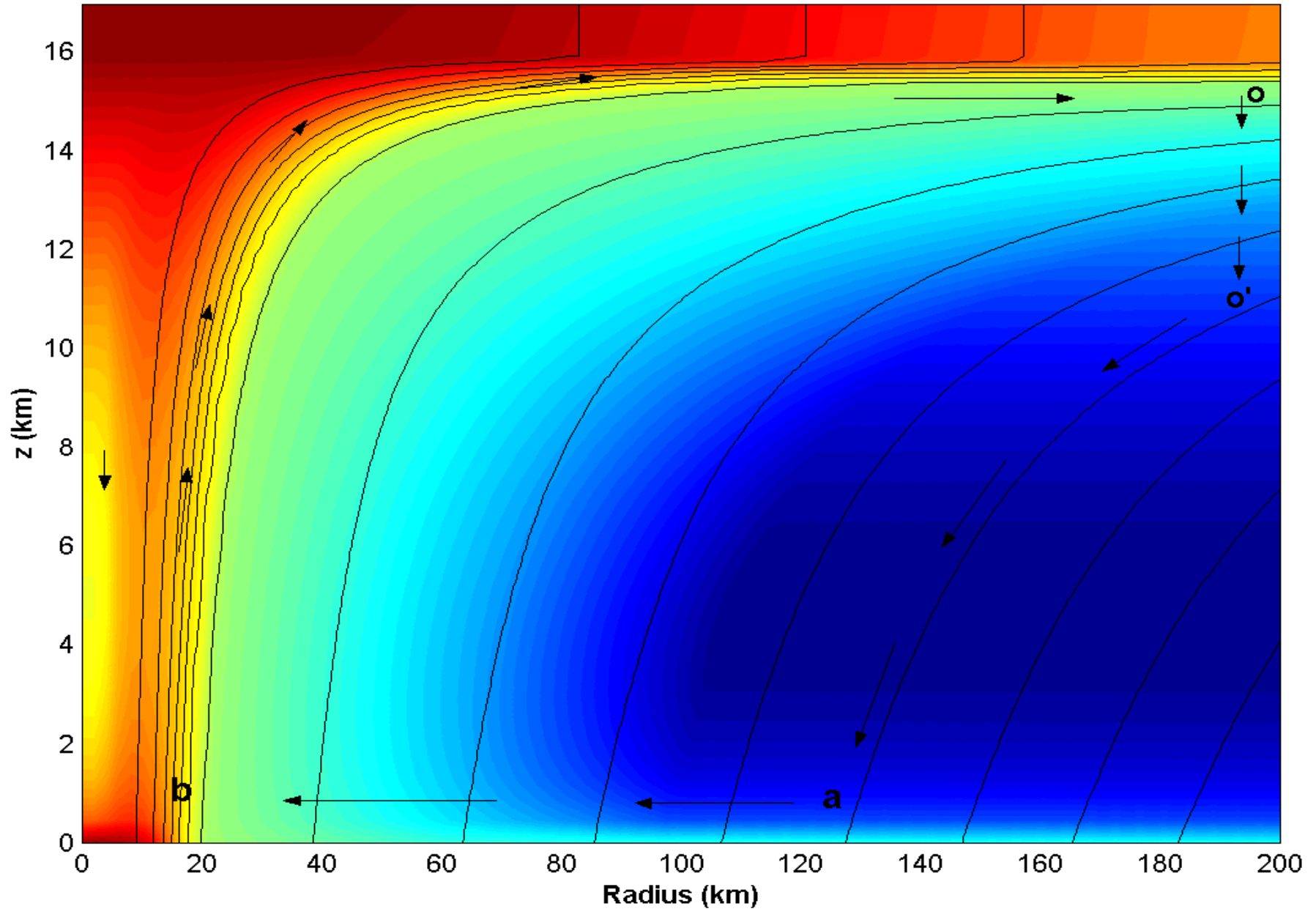

Carnot Theorem: Maximum efficiency results from a particular energy cycle:

- Isothermal expansion
- Adiabatic expansion
- Isothermal compression
- Adiabatic compression

Note: Last leg is not adiabatic in hurricane: Air cools radiatively. But since environmental temperature profile is moist adiabatic, the amount of radiative cooling is the same as if air were saturated and descending moist adiabatically.

Maximum rate of working:

$$W = \frac{T_s - T_o}{T_s} \dot{Q}$$

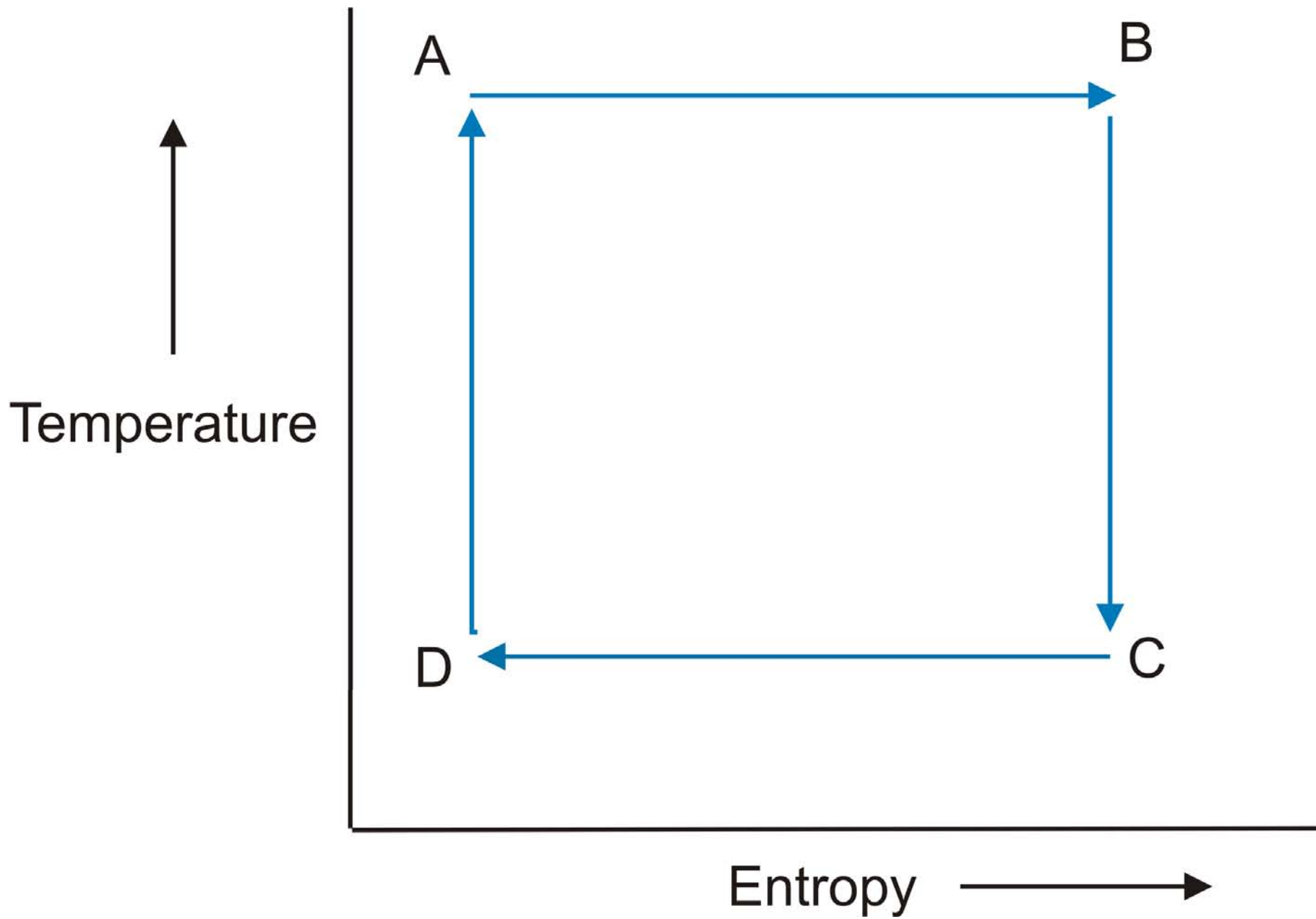

Total rate of heat input to hurricane:

$$\dot{Q} = 2\pi \int_0^{r_0} \rho \left[C_k |\mathbf{V}| (k_0^* - k) + C_D |\mathbf{V}|^3 \right] r dr$$

↑ **Surface enthalpy flux** ↗ **Dissipative heating**

In steady state, Work is used to balance frictional dissipation:

$$W = 2\pi \int_0^{r_0} \rho \left[C_D |\mathbf{V}|^3 \right] r dr$$

Plug into Carnot equation:

$$\int_0^{r_0} \rho \left[C_D |\mathbf{V}|^3 \right] r dr = \frac{T_s - T_o}{T_o} \int_0^{r_0} \rho \left[C_k |\mathbf{V}| \left(k_0^* - k \right) \right] r dr$$

If integrals dominated by values of integrands near radius of maximum winds,

$$\rightarrow |V_{\max}|^2 \cong \frac{C_k}{C_D} \frac{T_s - T_o}{T_o} \left(k_0^* - k \right)$$

Graph of Solution for particular values of coefficients:

Maximum Wind Speed (m/s)

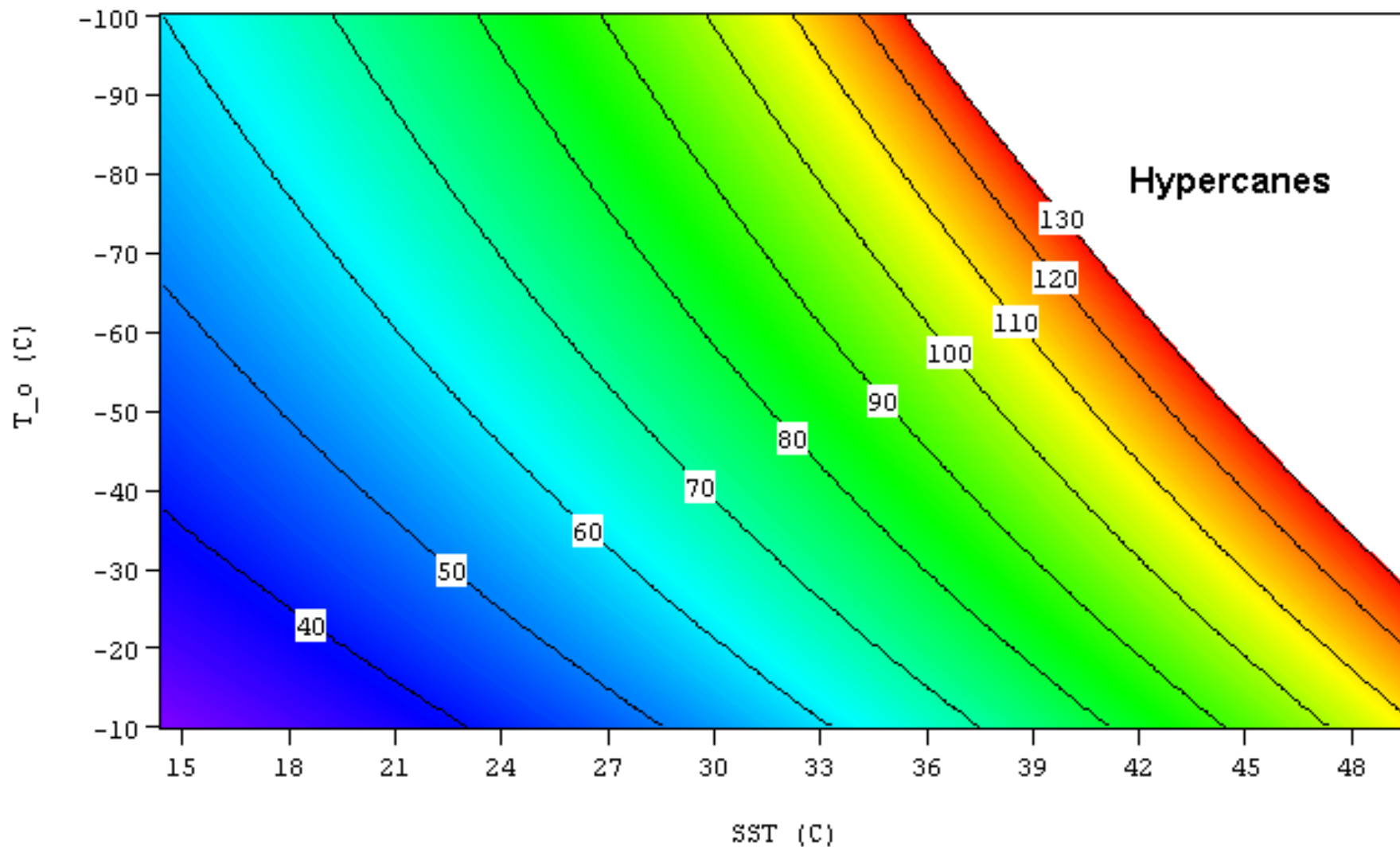

$$\mathcal{N} = 0.75 \quad C_k/C_D = 1.2$$

Maximum Annual Potential Intensity (MPH)

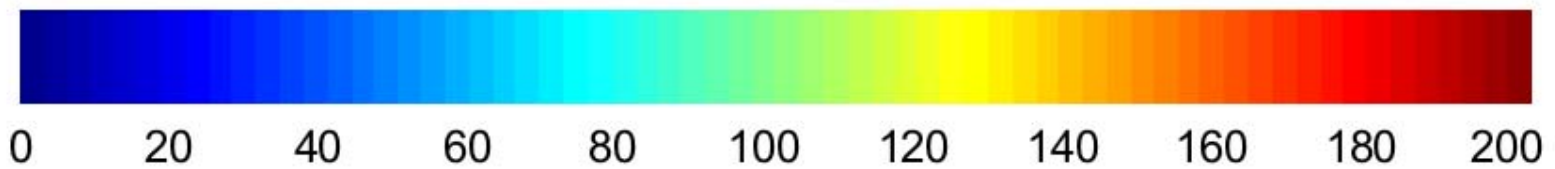
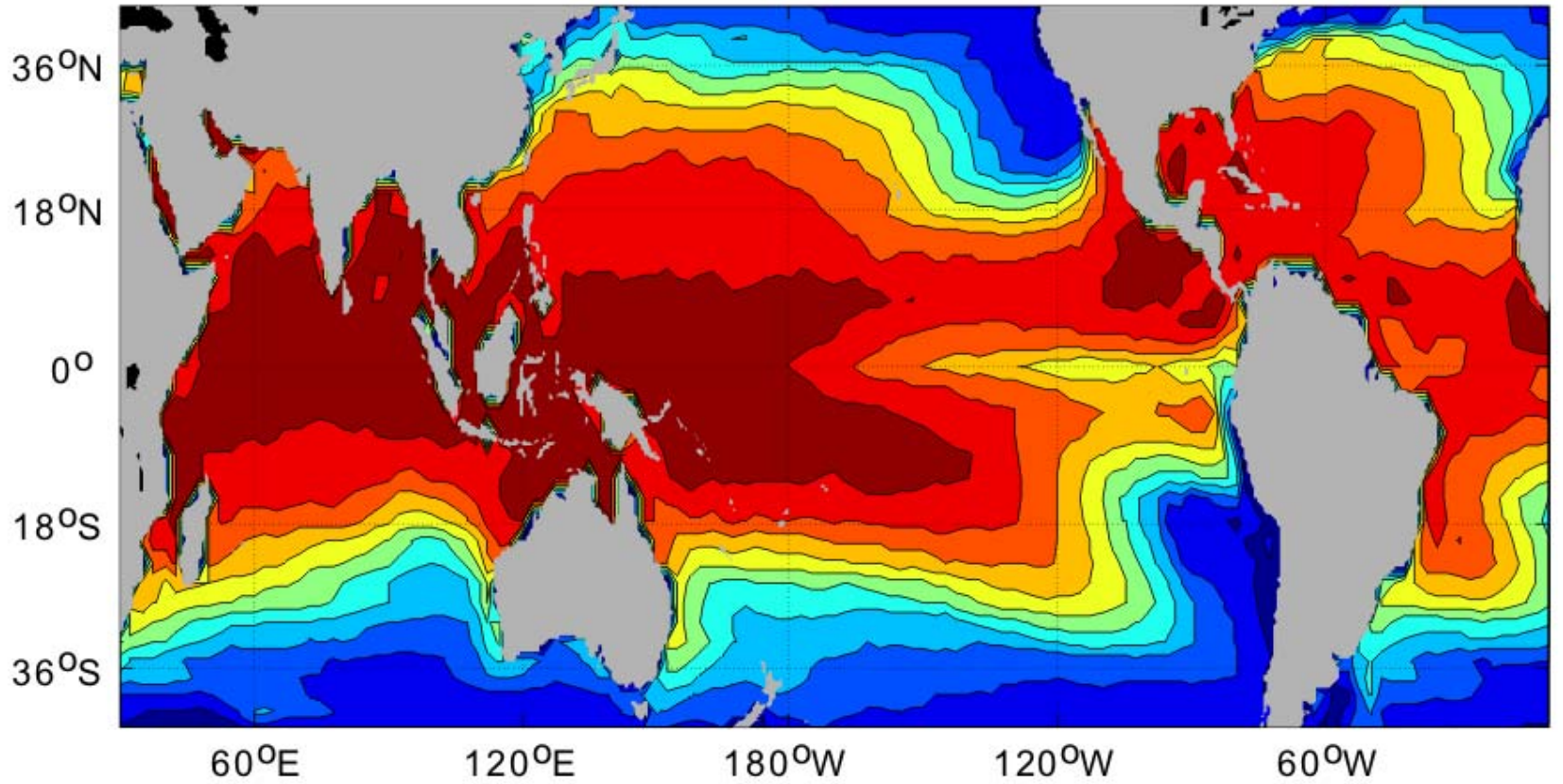

AUGUST MEAN

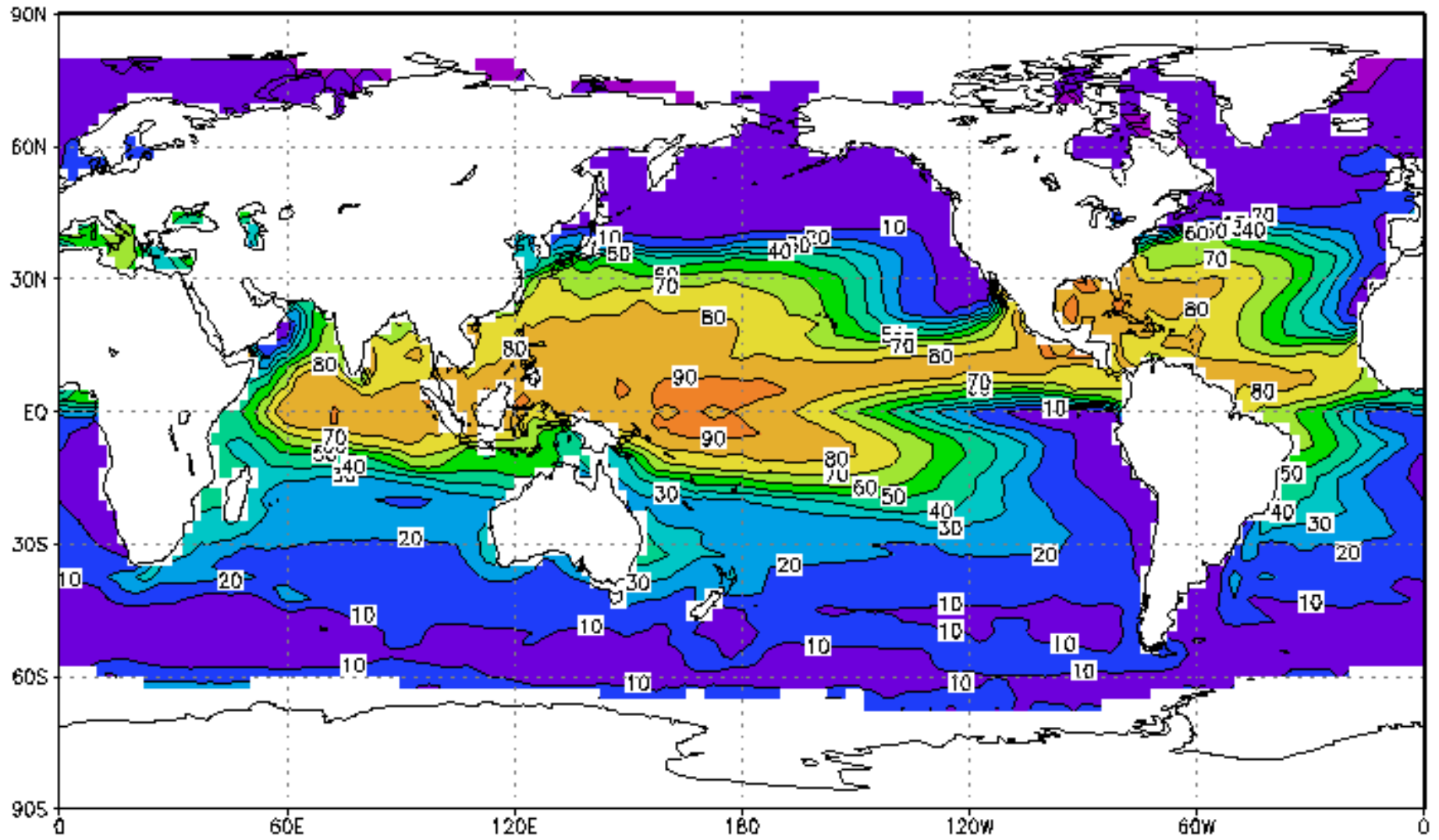

JANUARY MEAN

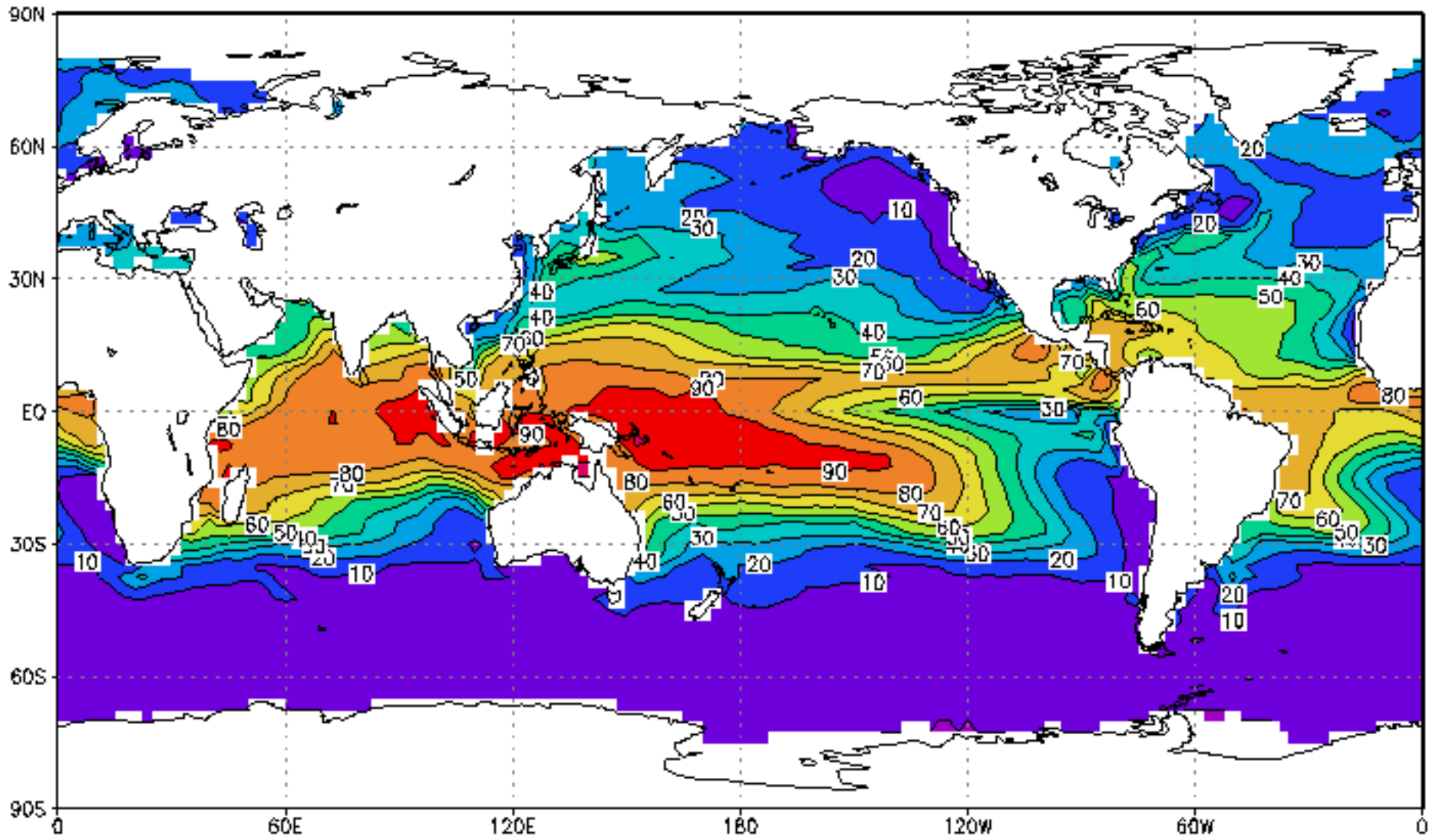

00 GMT 21 March 2008

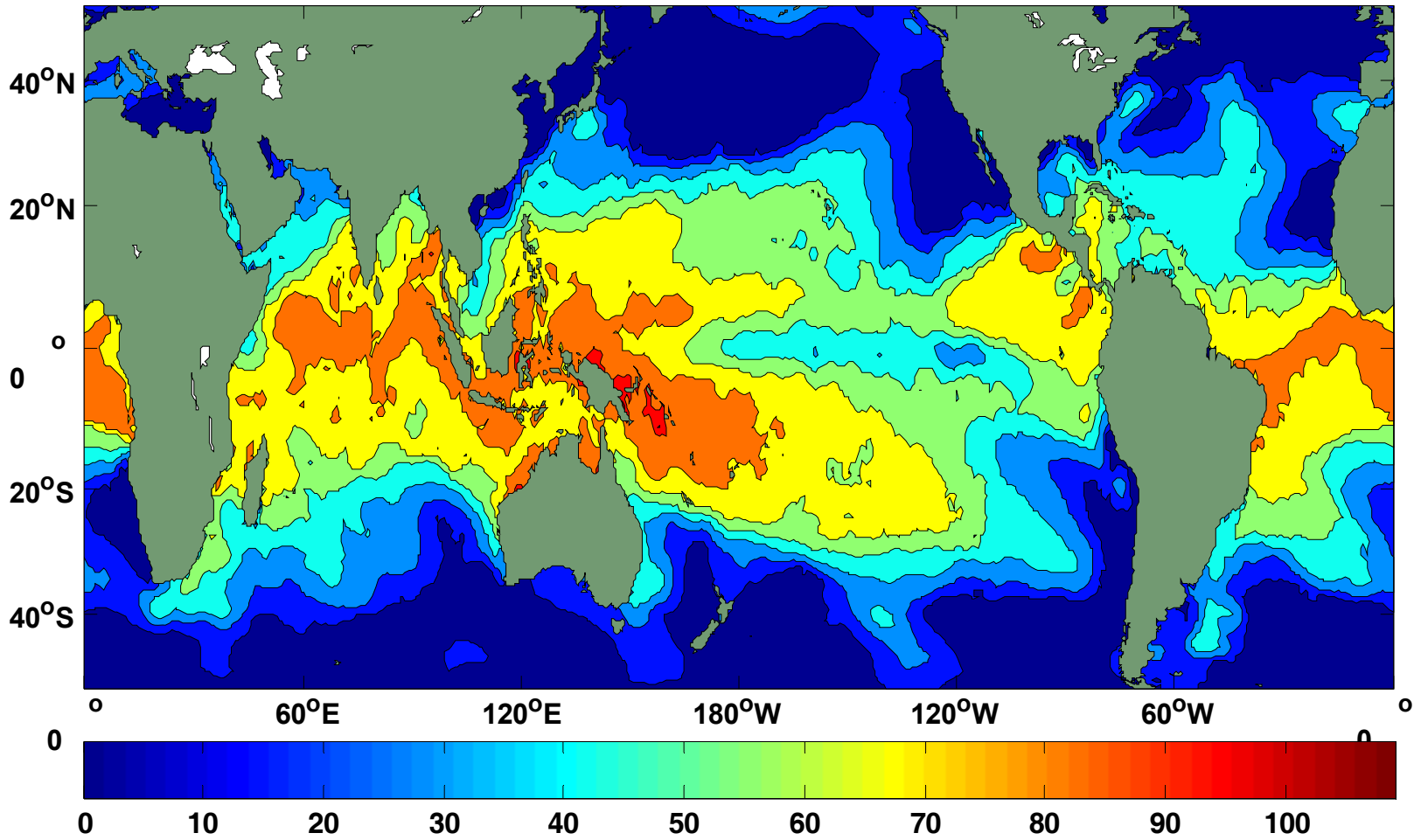

Numerical simulations

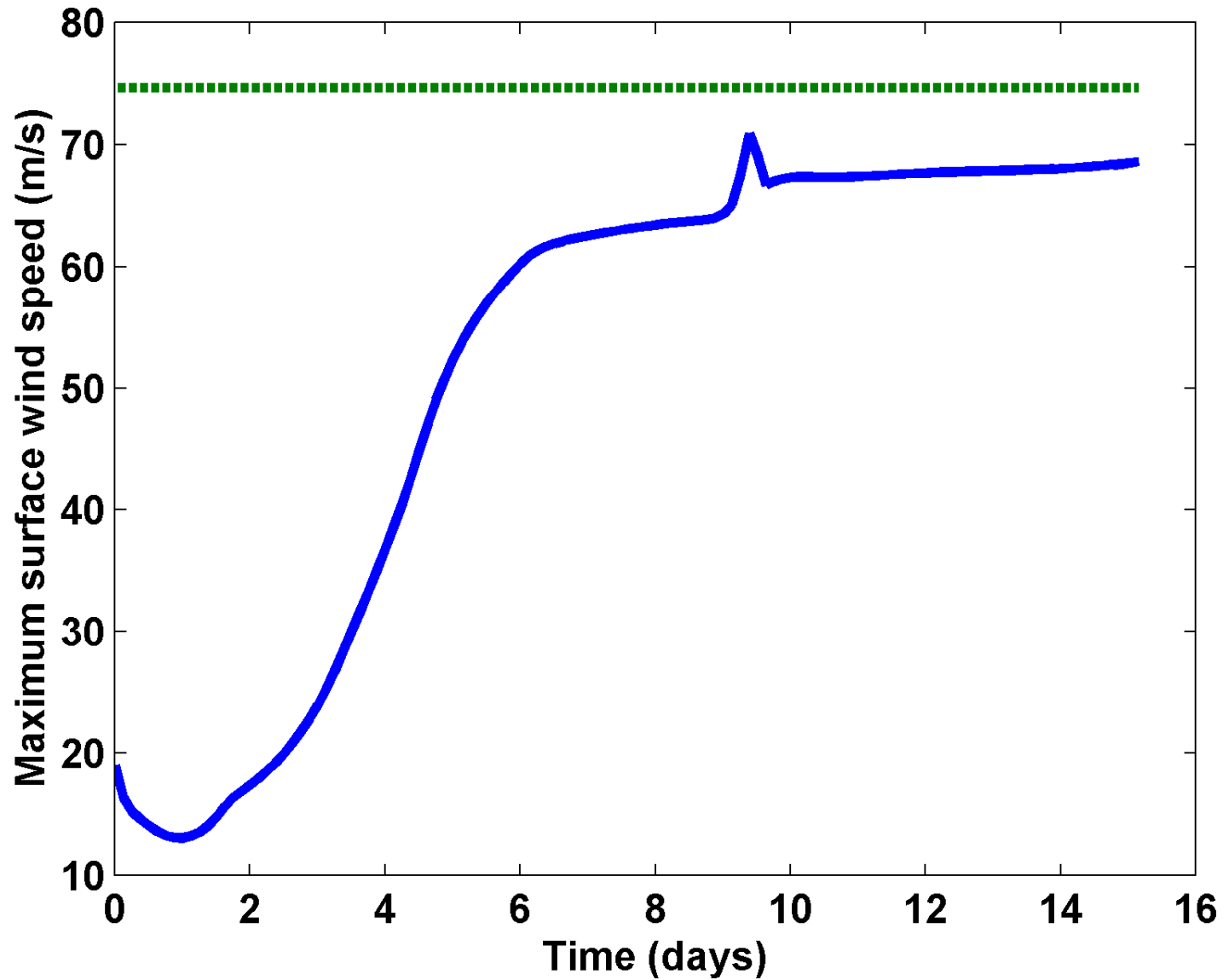

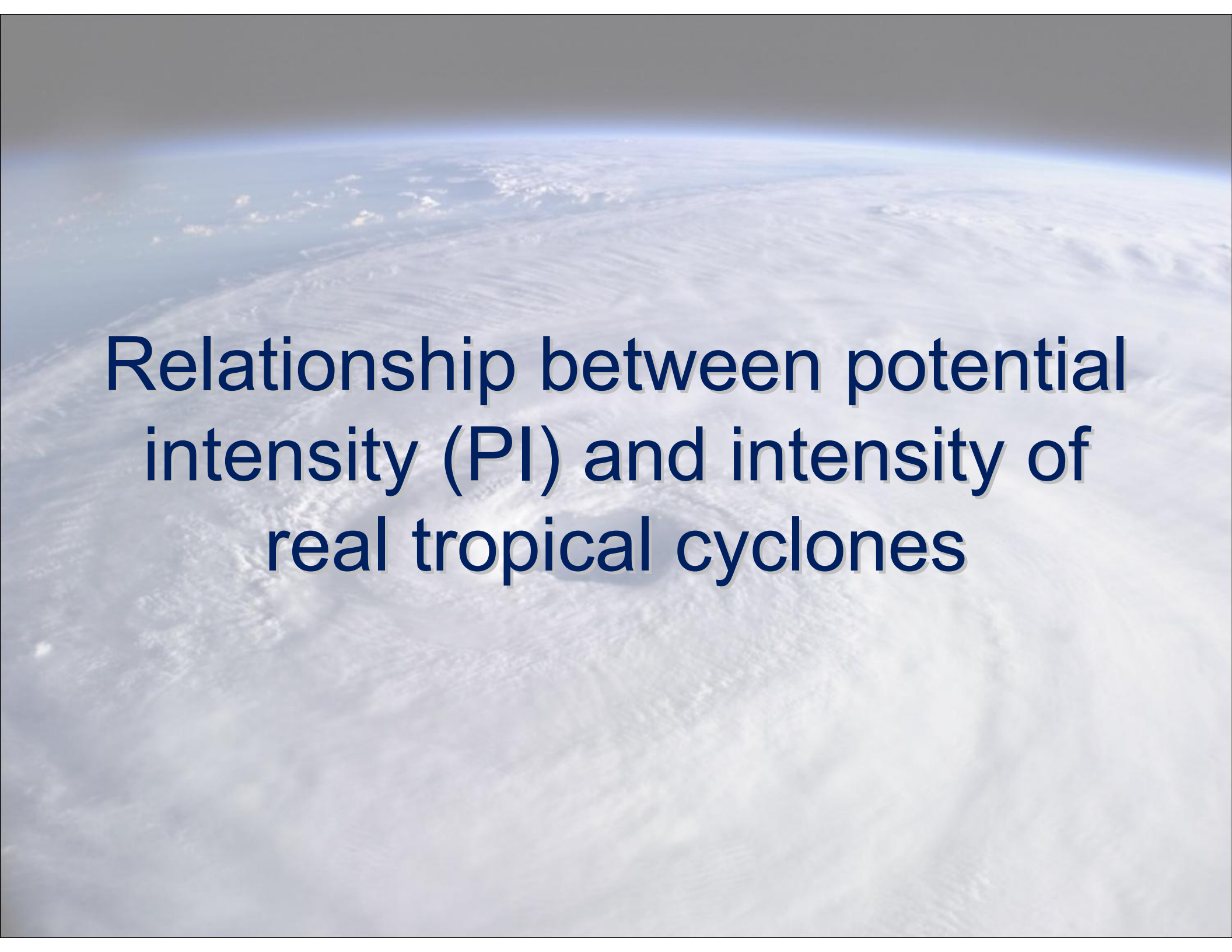
A satellite view of Earth's atmosphere, showing a vast expanse of white clouds and blue sky. The horizon is visible at the top of the frame, with a thin layer of atmosphere above it. The clouds are scattered and vary in density, creating a textured appearance. The overall scene is bright and clear, with a slight gradient from the horizon to the foreground.

Relationship between potential intensity (PI) and intensity of real tropical cyclones

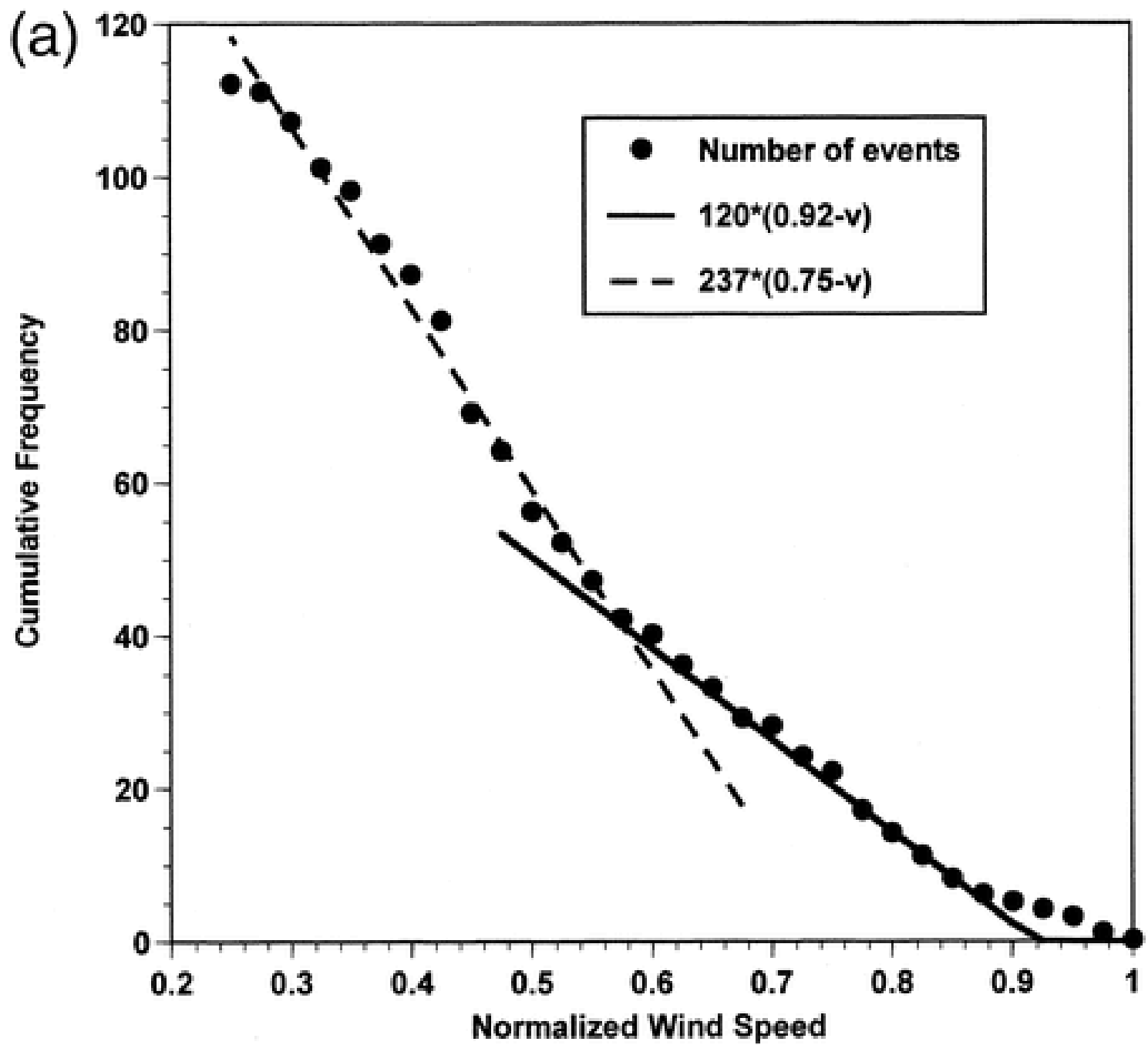

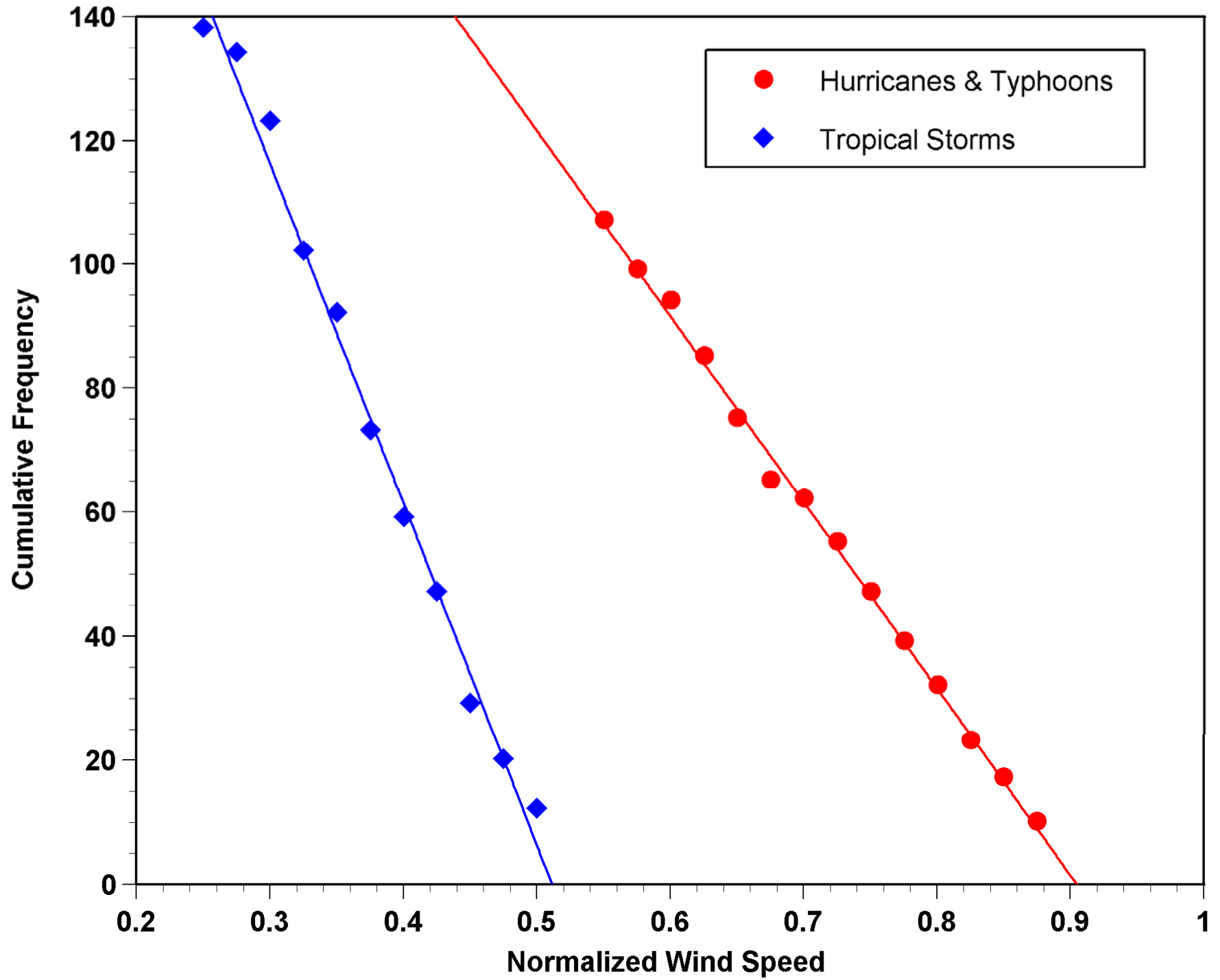

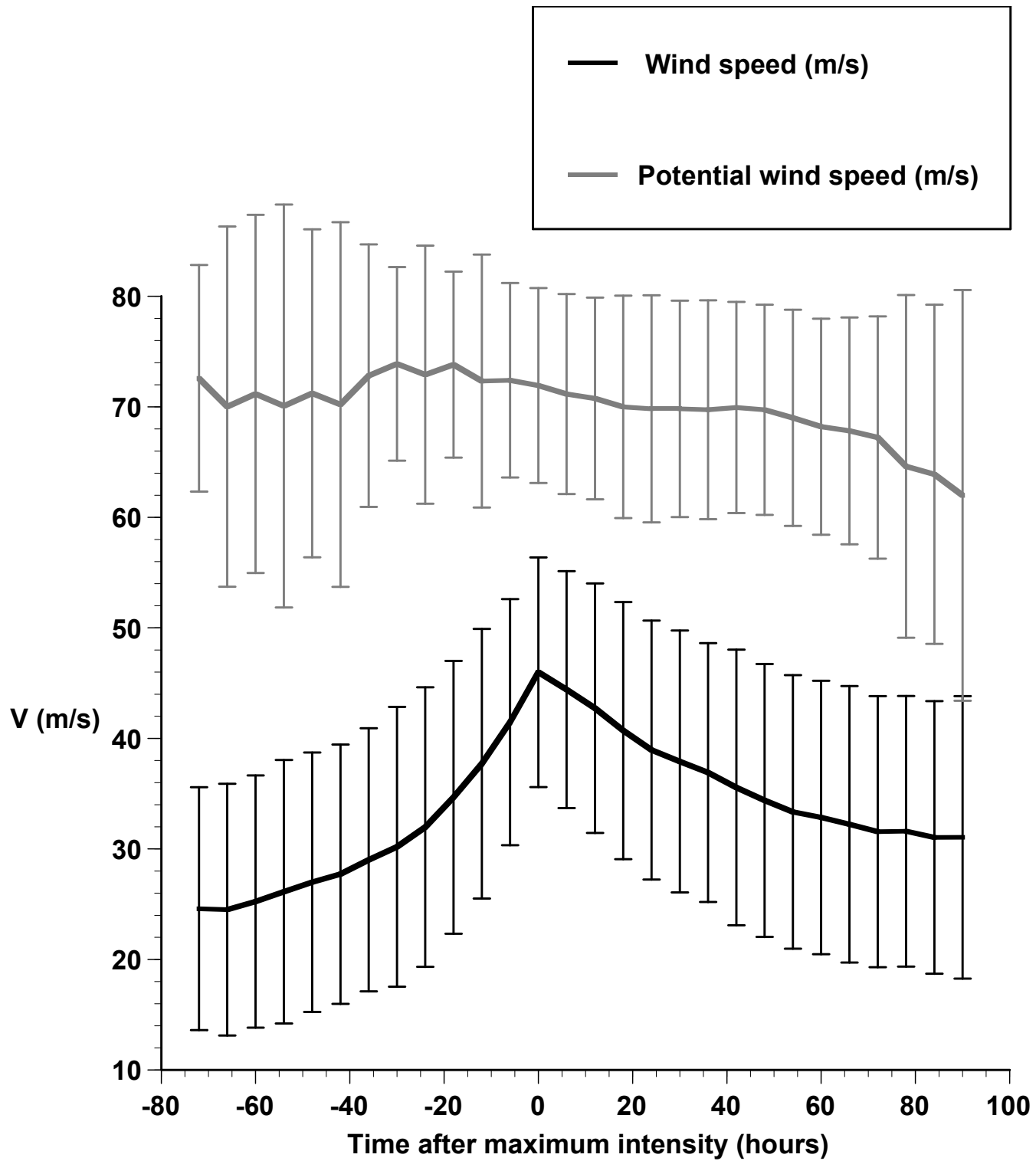

Evolution with respect to time of maximum intensity

(a)

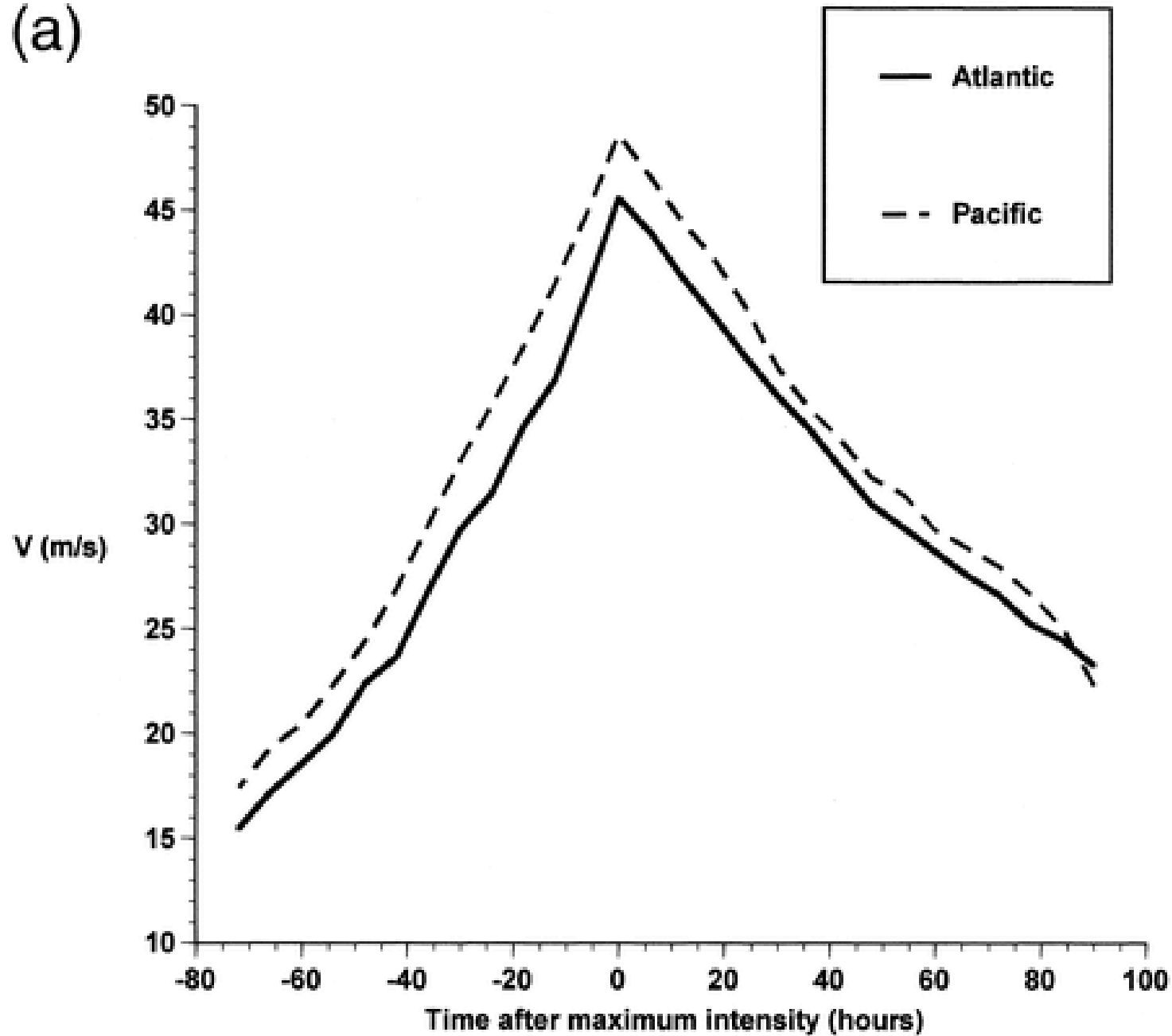

Evolution with respect to time of maximum intensity, normalized by peak wind

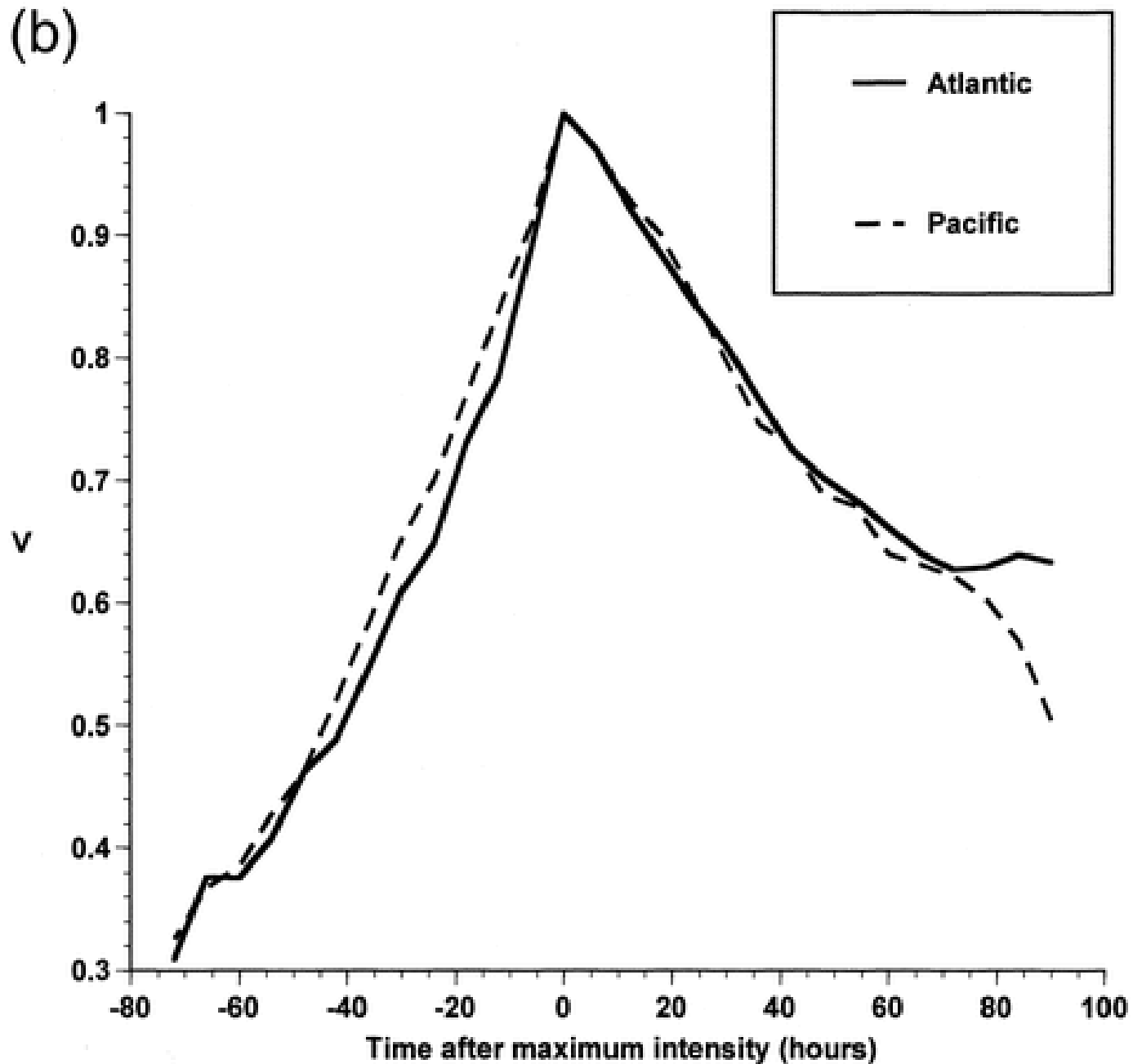

Evolution curve of Atlantic storms whose lifetime maximum intensity is limited by declining potential intensity, but not by landfall (a)

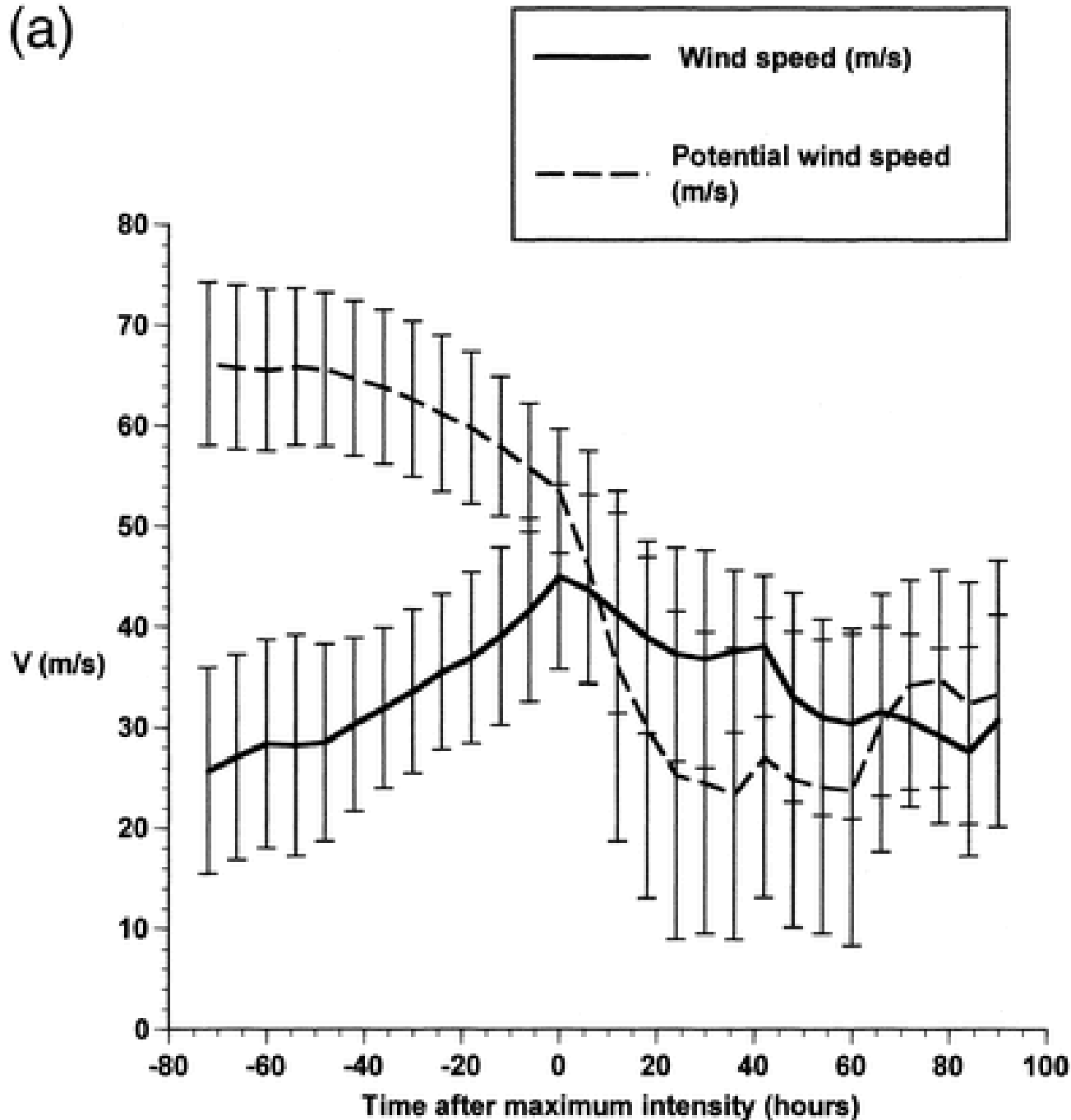

Evolution curve of WPAC storms whose lifetime maximum intensity is limited by declining potential intensity, but not by landfall

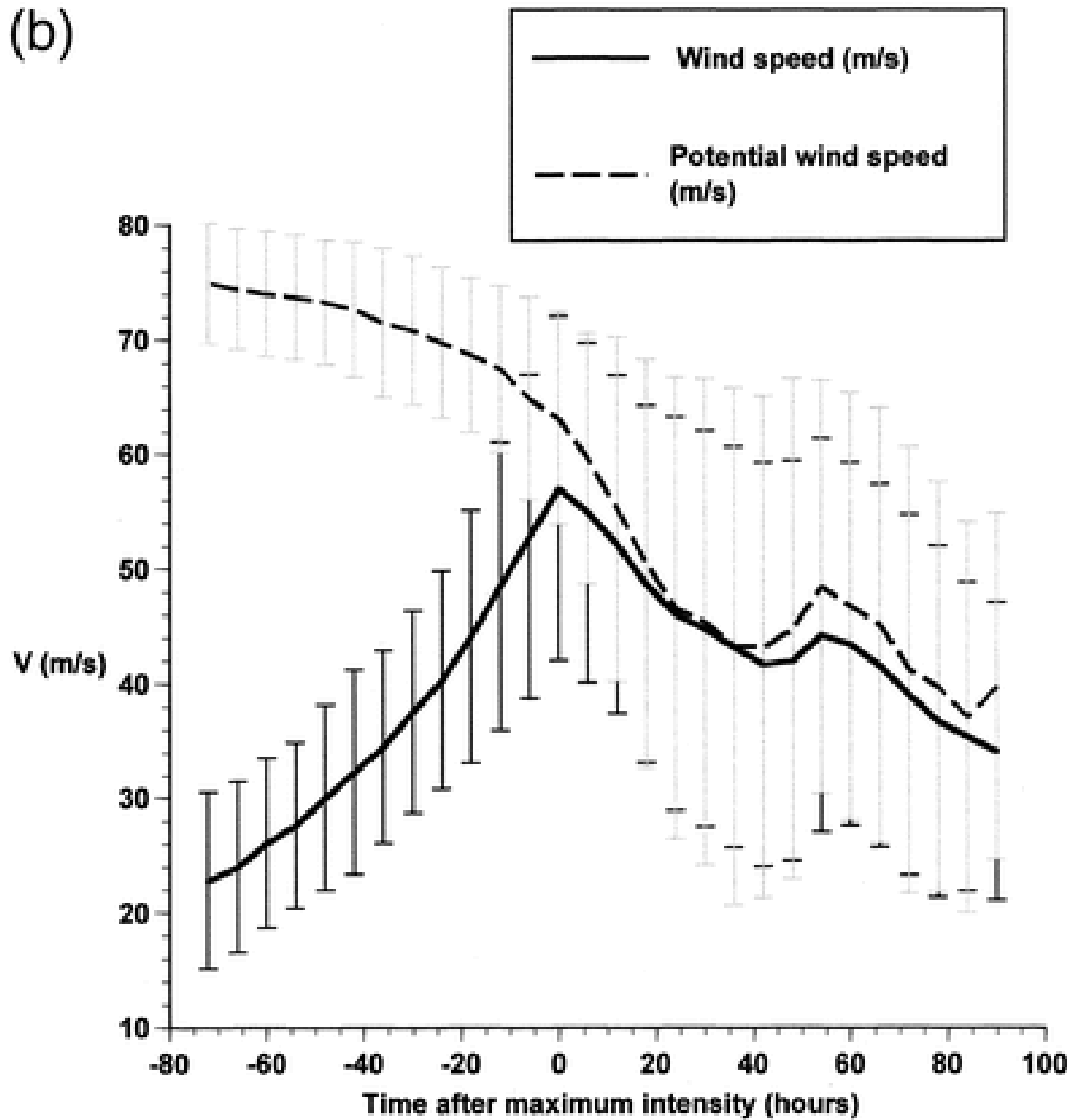

CDF of normalized lifetime maximum wind speeds of North Atlantic tropical cyclones of tropical storm strength (18 m s^{-1}) or greater, for those storms whose lifetime maximum intensity was limited by landfall. (a)

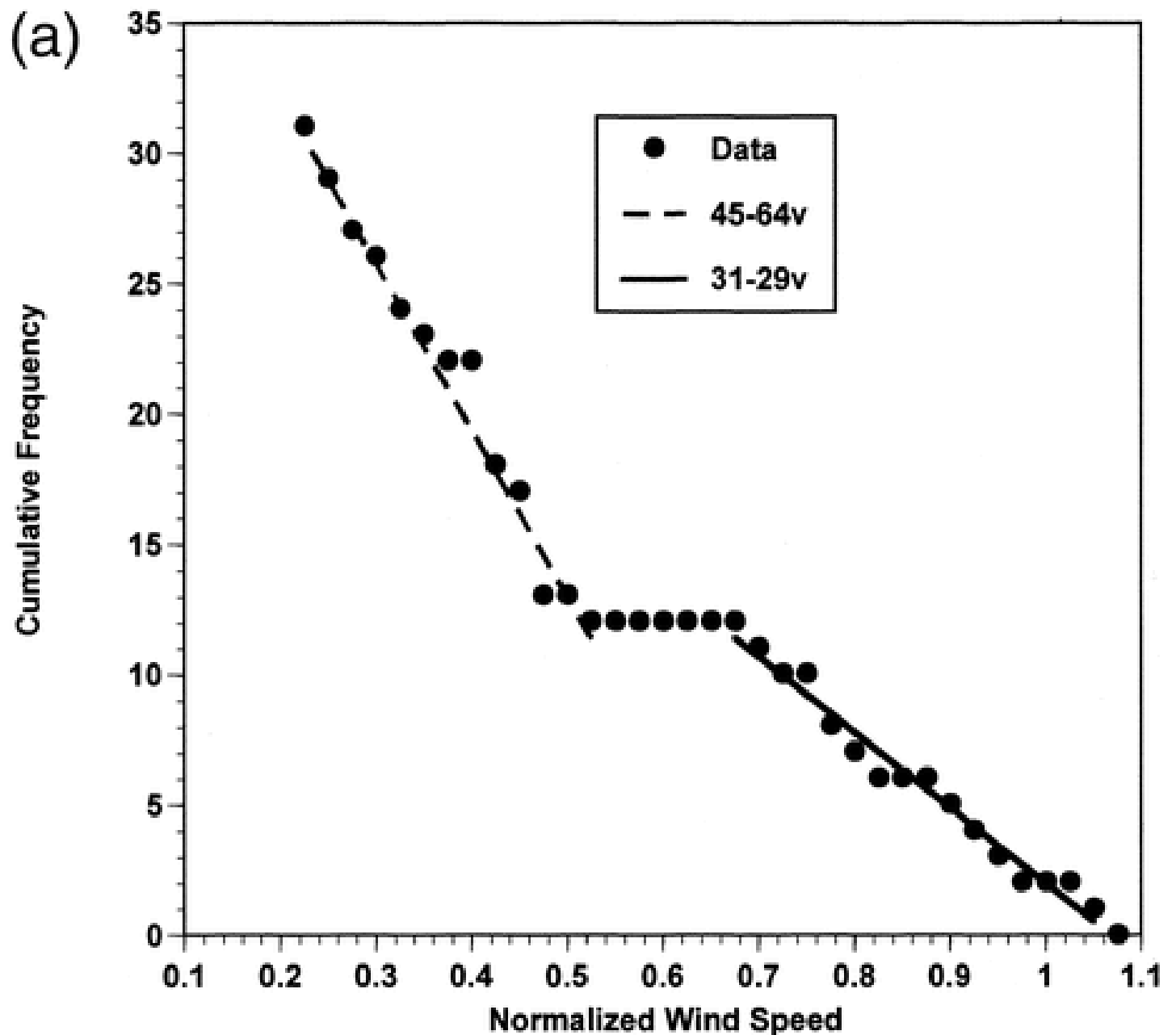

CDF of normalized lifetime maximum wind speeds of Northwest Pacific tropical cyclones of tropical storm strength (18 m s^{-1}) or greater, for those storms whose lifetime maximum intensity was limited by landfall.

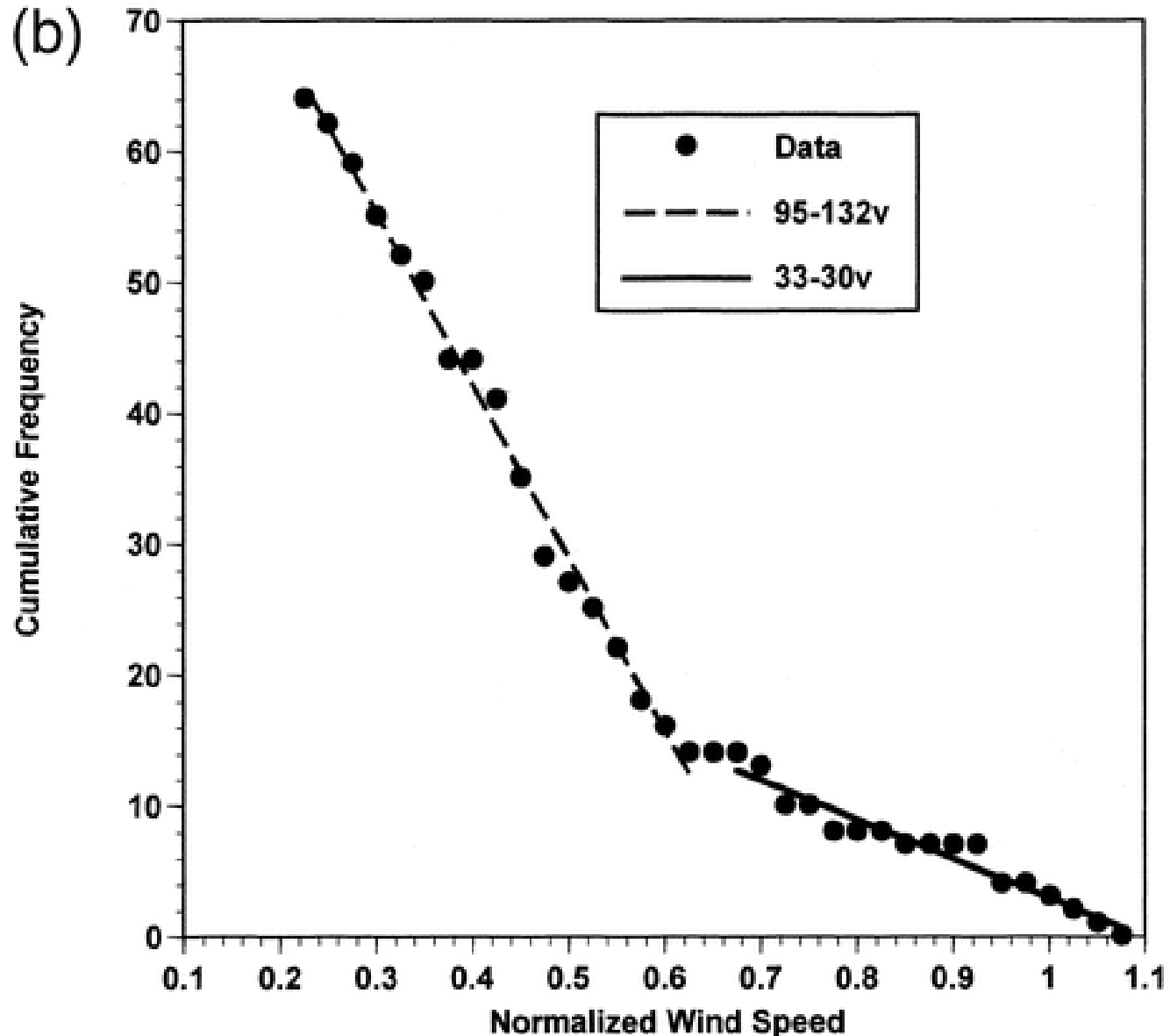

Evolution of Atlantic storms whose lifetime maximum intensity was limited by landfall

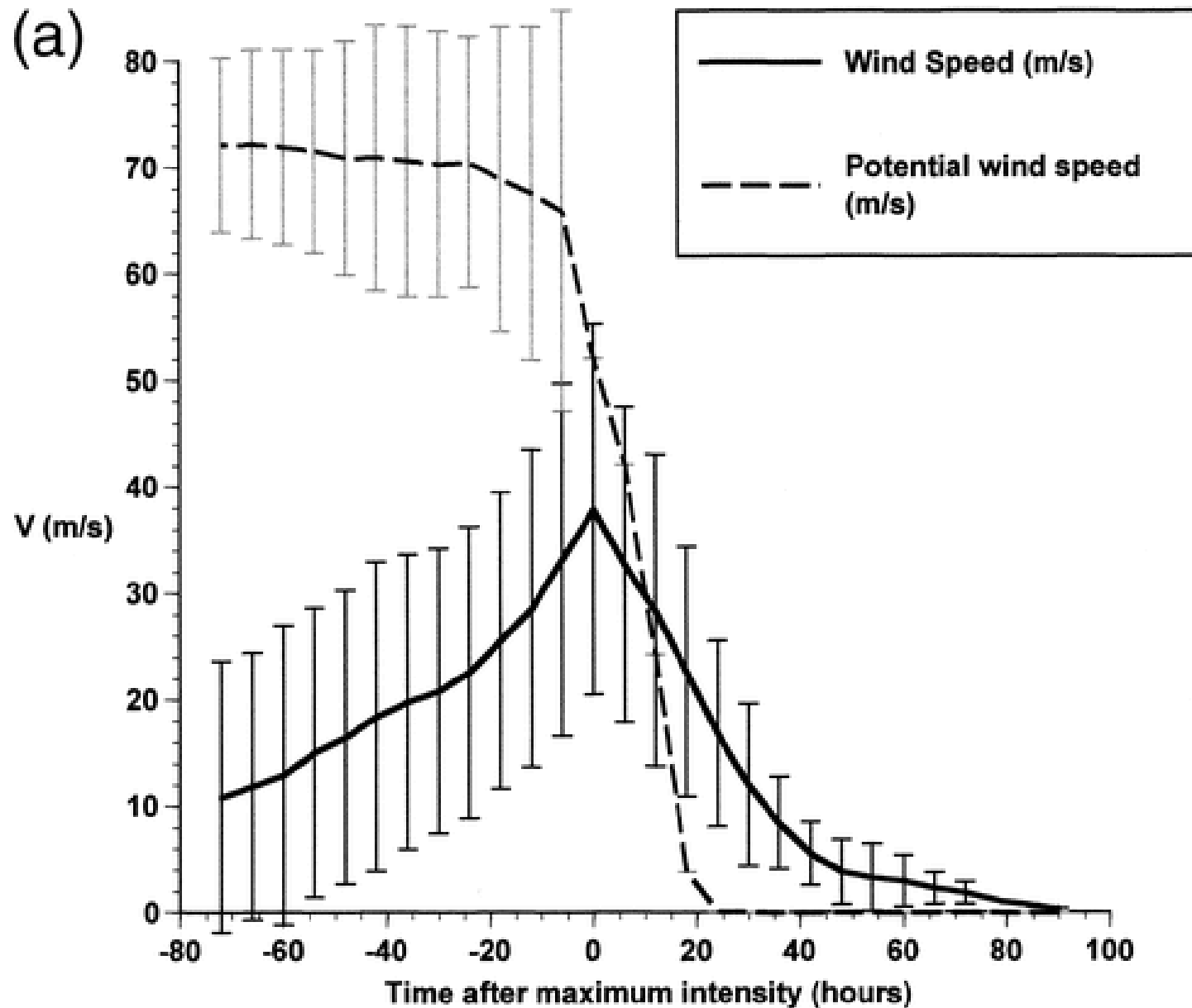

Evolution of Pacific storms whose lifetime maximum intensity was limited by landfall

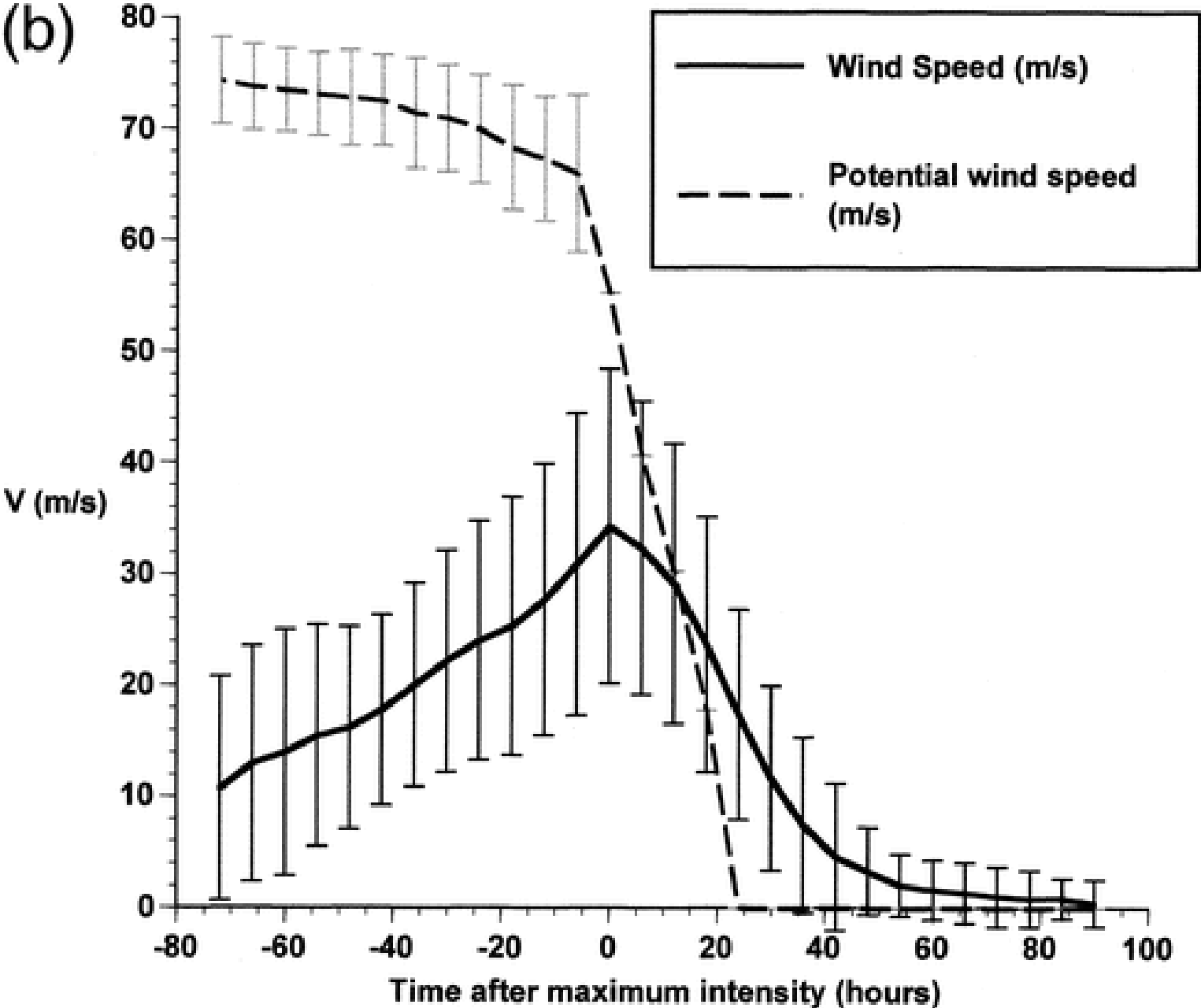

Composite evolution of landfalling storms

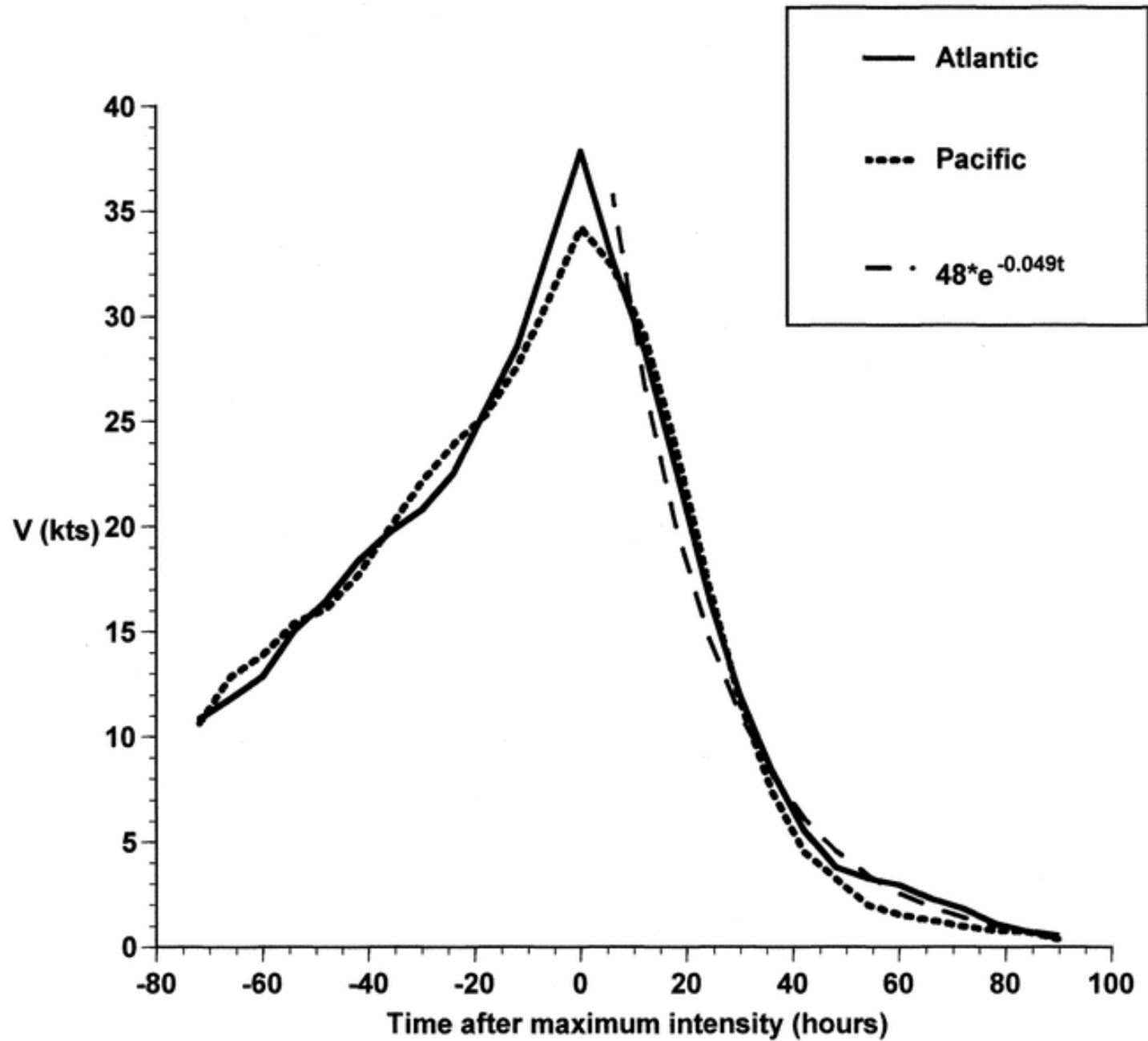

MIT OpenCourseWare
<http://ocw.mit.edu>

12.103 Science and Policy of Natural Hazards
Spring 2010

For information about citing these materials or our Terms of Use, visit: <http://ocw.mit.edu/terms>.