

SI engine combustion I

1

SI – engine combustion: How to “burn” things? Reactants → Products

Premixed

- Homogeneous reaction
 - Not limited by transport process
 - Fast/slow reactions compared with other time scale of interest
- Premixed flame
 - Examples: gas grill, SI engine combustion
- Detonation
 - Pressure wave driven reaction

Non-premixed

- Diffusion flame
 - Examples: candle, diesel engine combustion

2

SI ENGINE COMBUSTION

- Premixed flame
 - Laminar flame speed

- Turbulent enhancement of combustion
 - Wrinkled laminar flame

3

LAMINAR FLAME SPEEDS

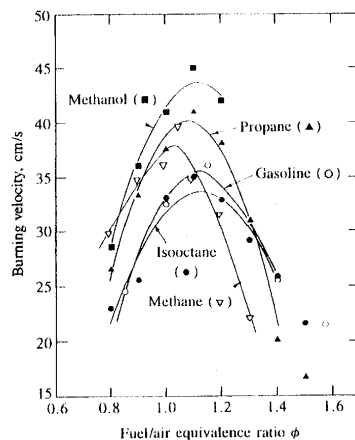

Fig. 9-25 Laminar burning velocity of several fuels as function of equivalence ratio, at 1 atm and 300 K.

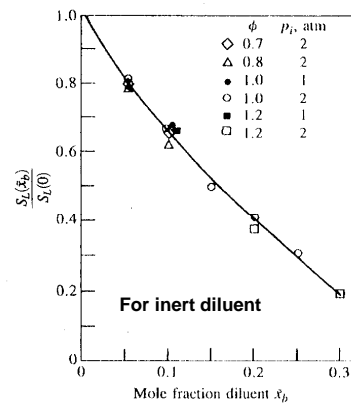

Fig. 9-26 Effect of burned gas mole fraction in unburned mixture on laminar burning velocity. Fuel: gasoline. (Note that actual burned gas from non-stoichiometric combustion would render the charge Φ different from the metered ϕ).

4

Schematic of SI engine flame propagation

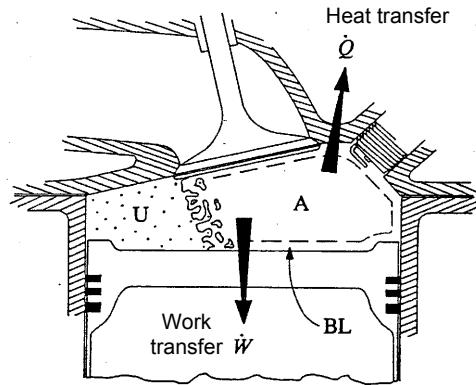
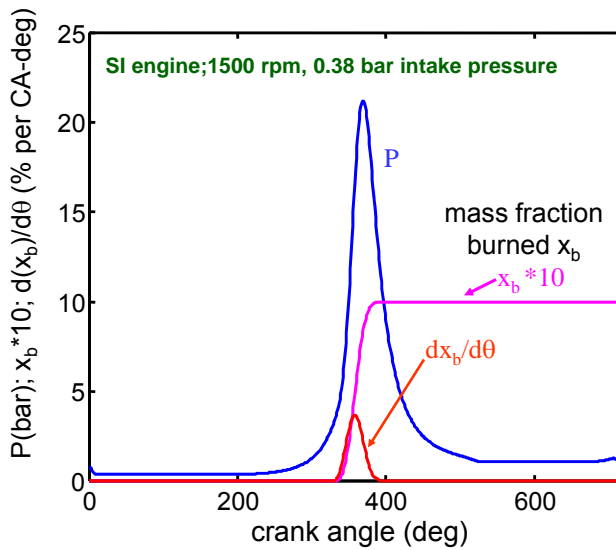

Fig. 9-4 Schematic of flame propagation in SI engine: unburned gas (U) to left of flame, burned gas to right. A denotes adiabatic burned-gas core, BL denotes thermal boundary layer in burned gas.

5

© McGraw-Hill Education. All rights reserved. This content is excluded from our Creative Commons license. For more information, see <https://ocw.mit.edu/help/faq-fair-use>.

Typical pressure and mass fraction burned (x_b) curves



Useful conversions:

1000 rpm:
6°CA/ms

1200 rpm:
20 Hz
(For 4 stroke engine
10 cycle/s
100 ms/cycle)

6

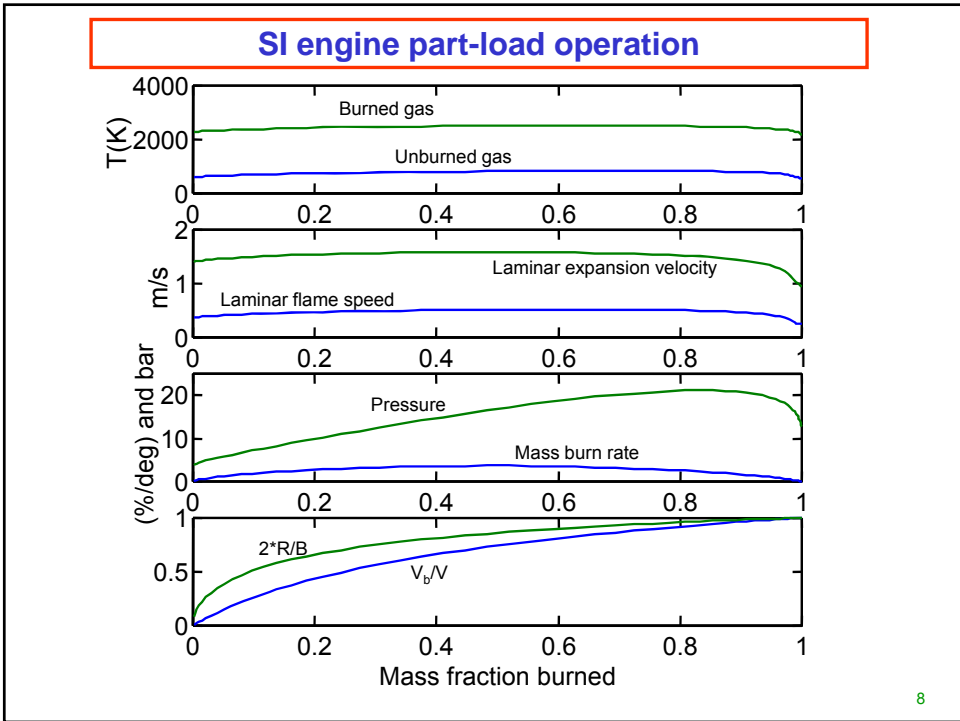
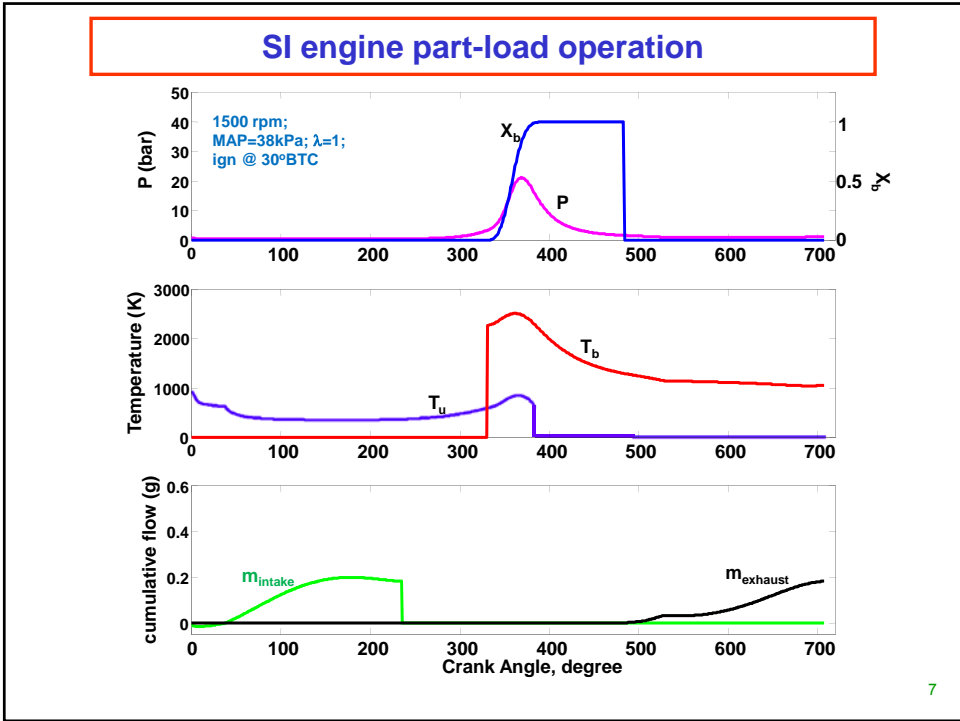

Combustion produced pressure rise

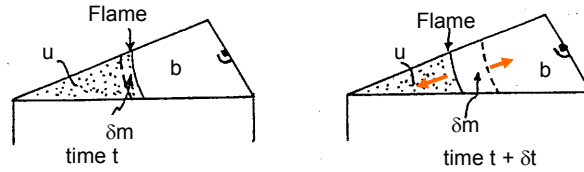

1. Pressure is uniform, changing with time
2. For mass δm : $h_b = h_u$ (because δm is allowed to expand against prevailing pressure)
3. T rise is a function of fuel heating value and mixture composition
 - e.g. at $\phi = 1$, $T_u \sim 700$ K, $T_b \sim 2800$ K
4. Hence burned gas expands: $\rho_b \sim \frac{1}{4} \rho_u$; $\delta V_b \sim 4 \delta V_u$

9

Combustion produced pressure rise

5. Since total volume is constrained. The pressure must rise by δp , and all the gas in the cylinder is compressed.
6. Both the unburned gas ahead of flame and burned gas behind the flame move away from the flame front
7. Both the unburned gas and burned gas temperatures rise due to the compression by the newly burned gas
8. Unburned gas state: since heat transfer is relatively small, the temperature is related to pressure by isentropic relationship
 - $T_u/T_{u,0} = (p/p_0)^{(\gamma_u - 1)/\gamma_u}$
9. Burned gas state:

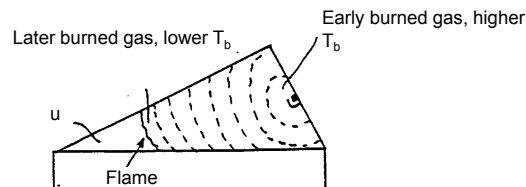

10

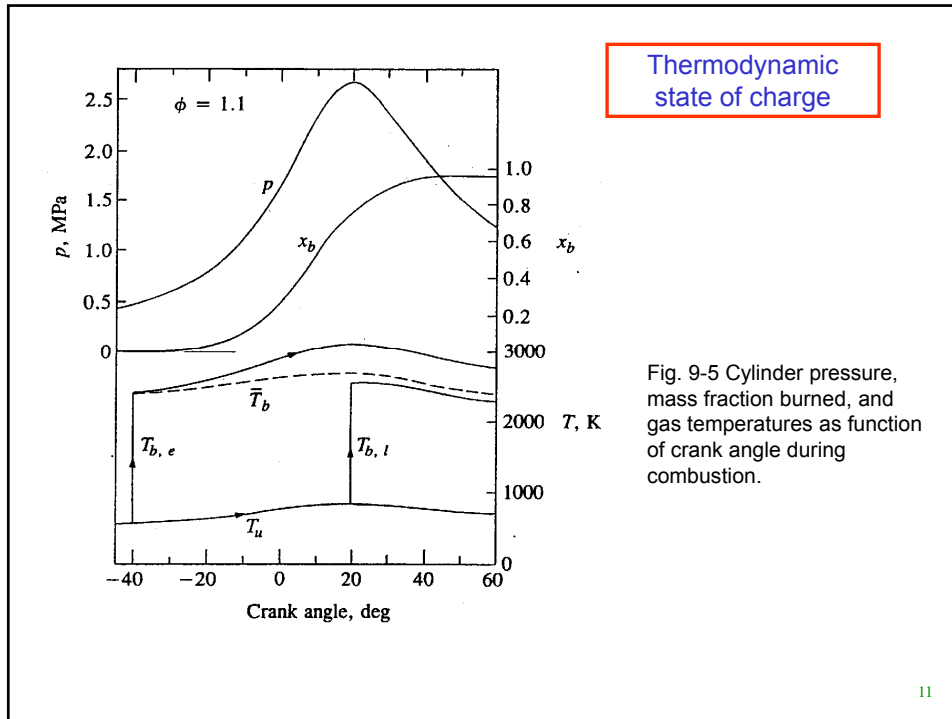

© McGraw-Hill Education. All rights reserved. This content is excluded from our Creative Commons license. For more information, see <https://ocw.mit.edu/help/faq-fair-use>.

Burn duration

- Burn duration as CA-deg. : measure of burn progress in cycle
- For modern fast-burn engines under medium speed, part load condition:
 - $\Delta\theta_{0-10\%} \sim 15^\circ$
 - $\Delta\theta_{0-50\%} \sim 25^\circ$
 - $\Delta\theta_{0-90\%} \sim 35^\circ$
- As engine speed increases, burn duration as CA-deg. :
 - Increases because there is less time per CA-deg.
 - Decreases because combustion is faster due to higher turbulence
 - Net effect: increases approximately as $\propto \text{rpm}^{0.2}$

Optimum Combustion Phasing

- Heat release schedule has to phase correctly with piston motion for optimal work extraction
- In SI engines, combustion phasing controlled by spark
- Spark too late
 - heat release occurs far into expansion and work cannot be fully extracted
- Spark too early
 - Effectively “lowers” compression ratio
 - increased heat transfer losses
 - Also likely to cause knock
- Optimal: Maximum Brake Torque (MBT) timing
 - MBT spark timing depends on speed, load, EGR, Φ , temperature, charge motion, ...
 - Torque curve relatively flat: roughly 5 to 7°CA retard from MBT results in 1% loss in torque

Spark timing effects

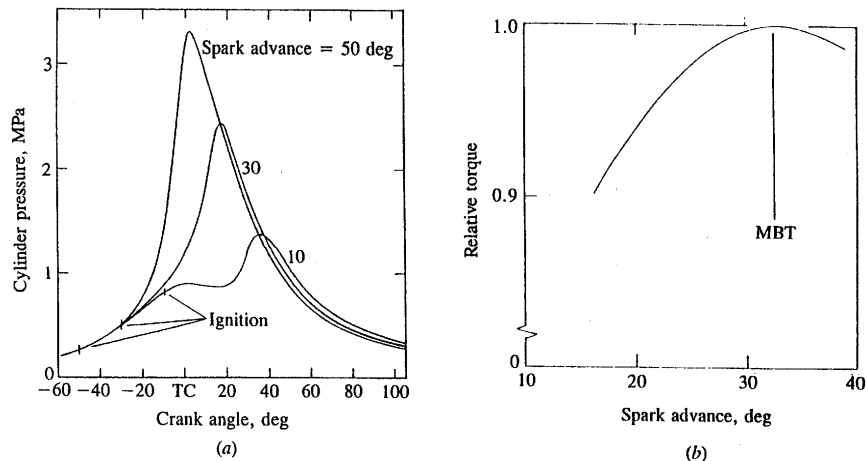
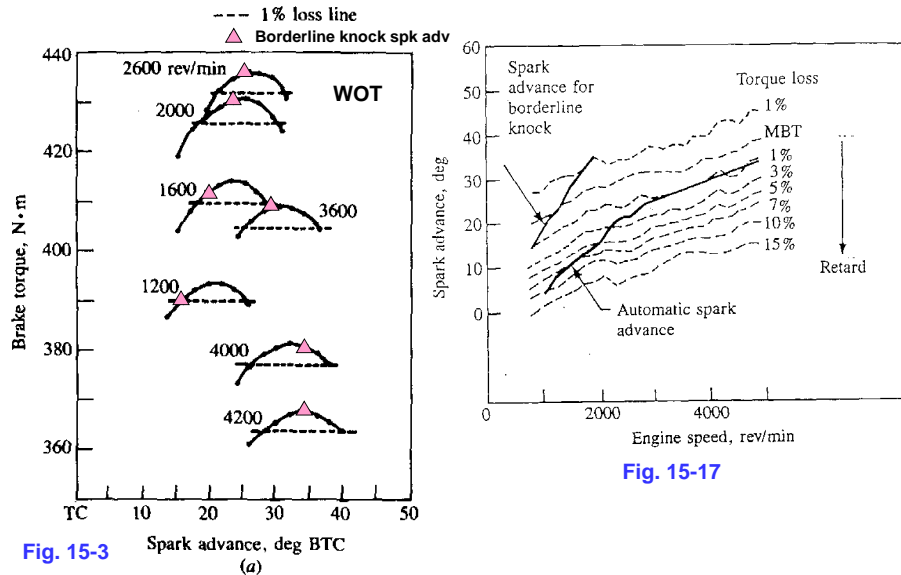

Fig. 9-3 (a) Cylinder pressure versus crank angle for overadvanced spark timing (50° BTDC), MBT timing (30° BTDC), and retarded timing (10° BTDC). (b) Effect of spark advance on brake torque at constant speed and A/F, at WOT

Control of spark timing



© McGraw-Hill Education. All rights reserved. This content is excluded from our Creative Commons license. For more information, see <https://ocw.mit.edu/help/faq-fair-use>.

Obtaining combustion information from engine cylinder pressure data

1. Cylinder pressure affected by:
 - a) Cylinder volume change
 - b) Fuel chemical energy release by combustion
 - c) Heat transfer to chamber walls
 - d) Crevice effects
 - e) Gas leakage
2. Obtaining accurate combustion rate information requires
 - a) Accurate pressure data (and crank angle indexing)
 - b) Models for phenomena a,c,d,e, above
 - c) Model for thermodynamic properties of cylinder contents
3. Available methods
 - a) Empirical methods (e.g. Rassweiler and Withrow SAE 800131)
 - b) Single-zone heat release or burn-rate model
 - c) Two-zone (burned/unburned) combustion model

Typical piezoelectric pressure transducer spec.

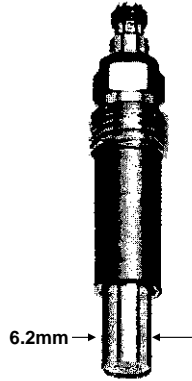

Kistler 6125

Technical Data

Range	bar	0 ... 250
Calibrated partial range	bar	0 ... 50
Overload	bar	300
Sensitivity	pC/bar	≈-16
Natural frequency	kHz	≈100
Linearity, all ranges	%FSO	≤±0.5
Acceleration sensitivity		
axial	bar/g	<0,0015
radial	bar/g	<0,0003
Operating temperature range	°C	-50 ... 350
Sensitivity shift		
20 ... 100°C	%	≈±1
20 ... 350°C	%	≤±3,5
200± 50°C	%	≈1
Insulation resistance		
bei 20°C	Ω	≥10 ¹³
Shock insulation	g	2000
Tightening sensitivity	Nm	10
Capacitance	pF	8
Weight	g	10
Plug, ceramic insulator	Type	10-32 UNF

© Source unknown. All rights reserved. This content is excluded from our Creative Commons license. For more information, see <https://ocw.mit.edu/help/faq-fair-use>.

Sensitivity of NIMEP to crank angle phase error

SI engine; 1500 rpm, 0.38 bar intake pressure

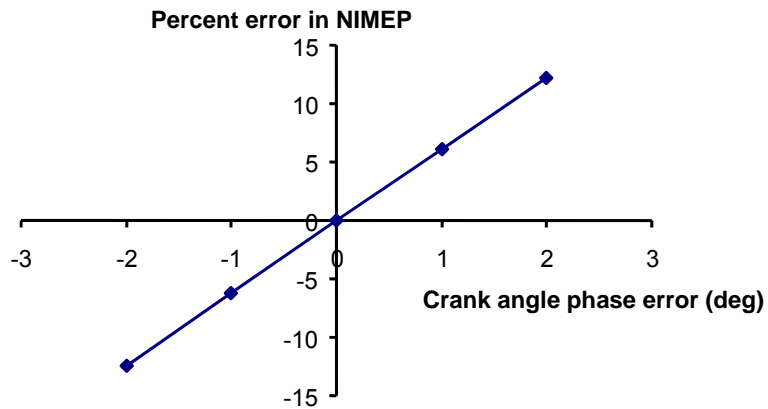

Cylinder pressure

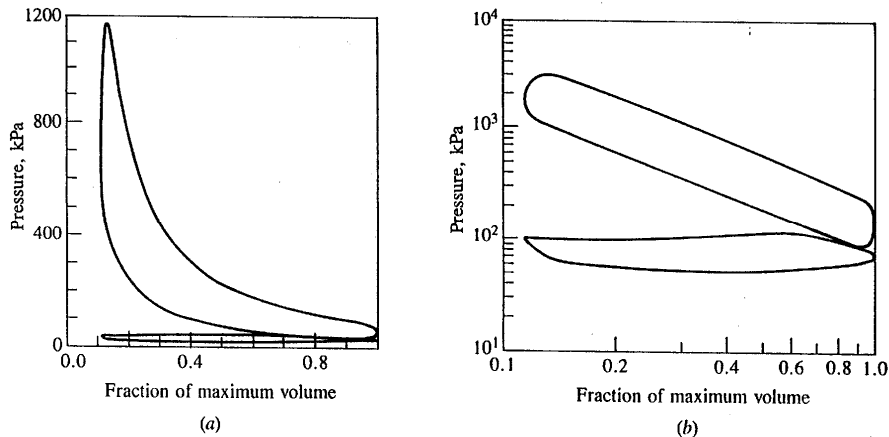
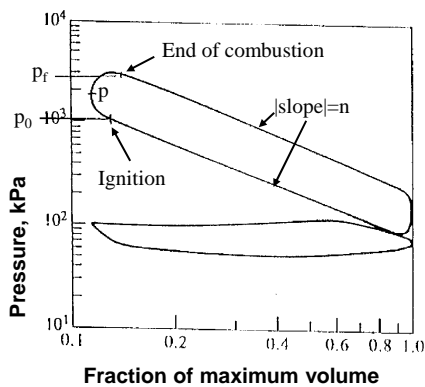

Fig. 9-10 (a) Pressure-volume diagram; (b) log p-log(V/V_{max}) plot; 1500 rpm, MBT timing, IMEP = 5.1 bar, $\Phi = 0.8$, $r_c = 8.7$, propane fuel.

19

© McGraw-Hill Education. All rights reserved. This content is excluded from our Creative Commons license. For more information, see <https://ocw.mit.edu/help/faq-fair-use>.

Burned mass analysis – Rassweiler and Winthrow (SAE 800131)



(There are two procedures described in the paper; this is one of them)

- Advantage: simple
 - Need only $p(\theta)$, p_0 , p_f and n
 - x_b always between 0 and 1
- During combustion $V = V_u + V_b$
Unburned gas volume, back tracked to spark (0)

$$V_{u,0} = V_u (p / p_0)^{1/n}$$

Burned gas volume, forward tracked to end of combustion (f)

$$V_{b,f} = V_b (p / p_f)^{1/n}$$

Mass fraction burned

$$x_b = 1 - \frac{V_{u,0}}{V_0} = \frac{V_{b,f}}{V_f}$$

Hence, after some algebra

$$x_b = \frac{p^{1/n} V - p_0^{1/n} V_0}{p_f^{1/n} V_f - p_0^{1/n} V_0}$$

20

© Society of Automotive Engineers. All rights reserved. This content is excluded from our Creative Commons license. For more information, see <https://ocw.mit.edu/help/faq-fair-use>.

Heat release analysis

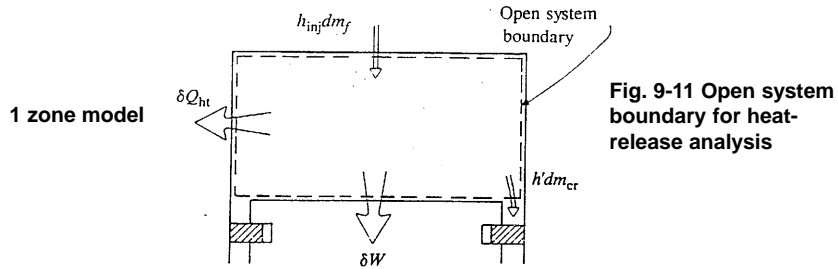

Fig. 9-11 Open system boundary for heat-release analysis

Energy balance:

Fuel chemical energy release	dQ_{ch}/dt	=	dU_g/dt + pdV/dt + dQ_{ht}/dt + $h' dm_{cr}/dt$ - $h_{inj} dm_f/dt$	Sensible energy change Work transfer Heat loss to walls Flow into crevice Injected enthalpy	}	Net heat released
------------------------------	--------------	---	---	---	---	-------------------

21

© McGraw-Hill Education. All rights reserved. This content is excluded from our Creative Commons license. For more information, see <https://ocw.mit.edu/help/faq-fair-use>.

Results of heat-release analysis

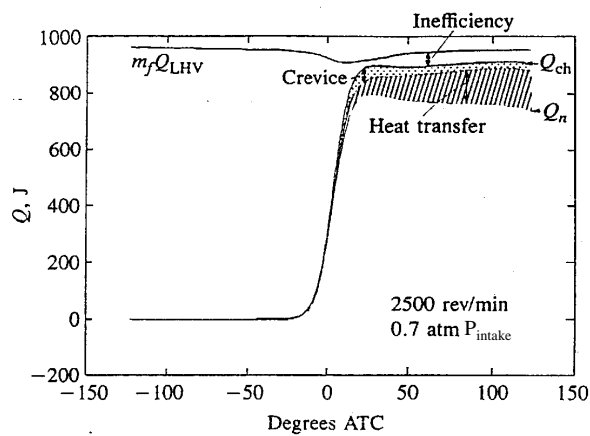

Fig. 9-12 Results of heat-release analysis showing the combustion inefficiency and the corrections due to heat transfer and crevice effect.

22

© McGraw-Hill Education. All rights reserved. This content is excluded from our Creative Commons license. For more information, see <https://ocw.mit.edu/help/faq-fair-use>.

Flow and Combustion Process in Spark-Ignition Engine

A Color Schieren Movie taken in a Special Visualization Engine

- Square piston engine
- Visualization by color-schlieren method
 - Captures density gradients
- Note:
 - Flame propagation process
 - Outgasing from crevices

23

Square piston flow visualization engine

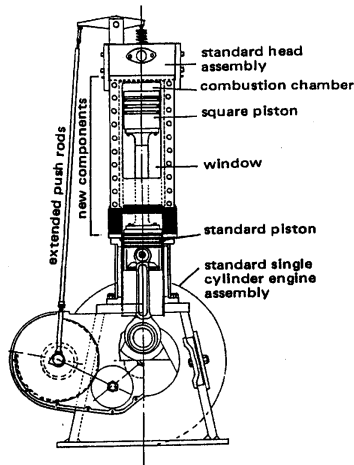

Bore	82.6 mm
Stroke	114.3 mm
Compression ratio	5.8
Operating condition	
Speed	1400 rpm
Φ	0.9
Fuel	propane
Intake pressure	0.5 bar
Spark timing	MBT

24

© Source unknown. All rights reserved. This content is excluded from our Creative Commons license. For more information, see <https://ocw.mit.edu/help/faq-fair-use>.

Flame Propagation (Fig 9-14)

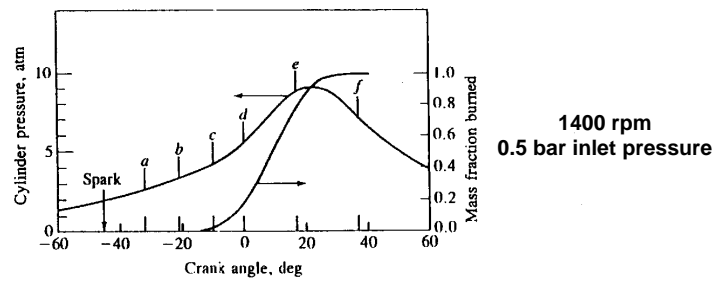
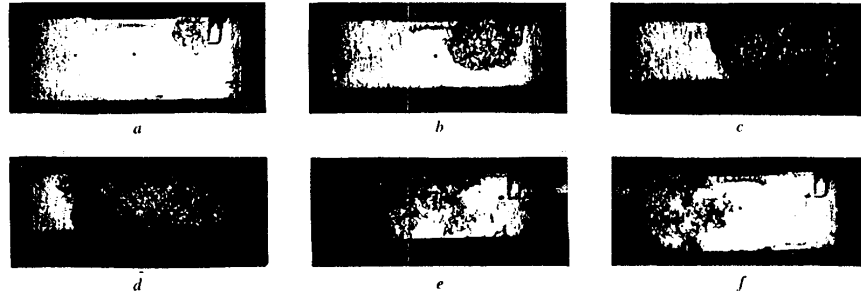

© McGraw-Hill Education. All rights reserved. This content is excluded from our Creative Commons license. For more information, see <https://ocw.mit.edu/help/faq-fair-use>.

MIT OpenCourseWare
<https://ocw.mit.edu>

2.61 Internal Combustion Engines
Spring 2017

For information about citing these materials or our Terms of Use, visit: <https://ocw.mit.edu/terms>.